



Service Manual

Proportioning Unit

"G-Connect" & "G-Connect+"

Issue 1.2 - 28/02/23
Ref. NR-00050-ENG



Before installing the unit and starting it up, carefully read all the technical and safety documentation included in this manual. Pay special attention to the information to know and understand the operation and the conditions of use of the unit. All of the information is aimed at enhancing User Safety and avoiding possible breakdowns derived from the incorrect use of the unit.



WARRANTY

HI-TECH SPRAY EQUIPMENT, S. A. (hereinafter “HI-TECH”) grants this Limited Guarantee to the original buyer (hereinafter the “Client”) for the unit and the original accessories given with the unit (hereinafter the “Product”) against any fault in the design, materials or manufacture of the Product at the time of the first purchase by the user and for a duration of two (2) years thereafter.

If during the guarantee period and under normal conditions of use, the Product should fail to work correctly due to defects of design, material or manufacture, the authorised distributor of the country where the HI-TECH Product or technical assistance service has been purchased shall repair or replace the Product in accordance with what is established in the following:

CONDITIONS

- a) The validity of this guarantee will be subject to the presentation of the original invoice issued by the HI-TECH authorised distributor for the sale of the Product along with the Product handed over for repair or replacement, which must show the date of purchase and the serial number. HI-TECH reserves the right to refuse to give the guarantee service when the indicated data fail to appear on the invoice or have been modified after the purchase of the Product.
- b) The repaired or replaced Product will continue to maintain the original guarantee for the time remaining until the end of the guarantee or for three (3) months from the repair date, if the remaining period of the original guarantee were shorter.
- c) This guarantee will not be applied to the faults in the Product caused by its faulty installation, the natural wear and tear of the components, any use other than that considered normal for this Product or which should fail to strictly comply with the instructions of use provided by HI-TECH; due to accident, carelessness, adjustments, alterations or modifications of the Product not authorised by HI-TECH or due to the use of accessories, heating devices, pumping equipment and/or dispensers that have not been approved or manufactured by HI-TECH.
- d) The guarantee applicable to the components and accessories forming part of the Product and which have not been made by HI-TECH will be limited to the guarantee offered by the original manufacturer thereof.

HI-TECH WILL NOT RECOGNISE ANY EXPRESS ORAL OR WRITTEN GUARANTEES OTHER THAN THIS PRINTED LIMITED GUARANTEE. ALL IMPLICIT GUARANTEES, INCLUDING, WITHOUT LIMIT, ADAPTATION FOR A SPECIFIC USE, ARE SUBJECT TO THE DURATION OF THIS WRITTEN GUARANTEE. HI-TECH DOES NOT ASSUME ANY KIND OF COMMITMENT OR RESPONSIBILITY FOR ALL POSSIBLE DAMAGE OR EXPENSE CAUSED BY FAULTS IN THE OUTPUT OF THE PRODUCT, ITS WORKING OR THE DISPENSING OF MATERIAL THROUGH THE PRODUCT, INCLUDING, WITHOUT LIMITATION, ALL EXPENSES CAUSED BY DAMAGE TO PEOPLE OR PROPERTY. EQUALLY, HI-TECH WILL IN NO CASE ACCEPT LIABILITY FOR THE LOSS OF SPECULATIVE PROFITS OR COMMERCIAL LOSSES. ALL REPAIRS OR REPLACEMENT OF FAULTY PRODUCTS WILL CONSTITUTE THE COMPREHENSIVE FULFILMENT OF HI-TECH'S OBLIGATIONS WITH RESPECT TO THE CLIENT. HI-TECH DOES NOT IN ANY WAY GUARANTEE THE SUITABILITY OR APTITUDE OF ITS PRODUCT FOR ANY PARTICULAR PURPOSE OR APPLICATION.

All information provided on components which have not been manufactured by HI-TECH and which is based on reports received from the original manufacturer, though considered precise and reliable, is provided without any guarantee or responsibility of any explicit or implicit kind.

All concession, sale or financial leasing of the Product by HI-TECH in no case explicitly or implicitly constitutes any authorisation, acceptance or concession for the use of any rights or patents, nor does it encourage, nurture or back their infringement.

The restrictions on the guarantee suppose no limitation on the legal rights of the consumer established in applicable national legislation, nor do they affect any rights derived from the bargain and sale agreement between the consumer and supplier.



All information provided in this manual has been included in the confidence that it is true, although it does not constitute any responsibility or implicit or explicit guarantee. HI-TECH reserves the right at any time and without prior warning to make all improvements and modifications necessary to this manual, in order to rectify any possible typographical errors, increase the information contained or insert the changes caused to the characteristics and performance of the unit.

SAFETY AND HANDLING

The equipment described in this manual has been designed and manufactured in compliance with the following European Directives, following as application guide the harmonized standards detailed and in conformity with the relevant UK Statutory Instruments (and their amendments):



Directive 2006/42/EC on machinery (UK Supply of Machinery (Safety) Regulations 2008)

UNE EN 12100:2012 (BS EN ISO 12100:2010)

Directive 2014/30/EU on electromagnetic compatibility (UK Electromagnetic Compatibility Regulations 2016) (*)

UNE EN 55011 (BS UNE EN 55011)

UNE EN 55016-2-1 (BS UNE EN 55016-2-1); UNE EN 55016-2-3 (BS UNE EN 55016-2-3); UNE EN 55032 (BS UNE EN 55032)

UNE EN 61000-3-2 (BS UNE EN 61000-3-2); UNE EN 61000-3-3 (BS UNE EN 61000-3-3); UNE EN 61000-4-2 (BS UNE EN 61000-4-2); UNE EN 61000-4-3 (BS UNE EN 61000-4-3); UNE EN 61000-4-4 (BS UNE EN 61000-4-4); UNE EN 61000-4-5 (BS UNE EN 61000-4-5); UNE EN 61000-4-6 (BS UNE EN 61000-4-6); UNE EN 61000-4-8 (BS UNE EN 61000-4-8); UNE EN 61000-4-11 (BS UNE EN 61000-4-11)

() The Unit may experience a degradation of its immunity in the presence of radiated electromagnetic disturbances (IEC 61000-4-3) in the frequency range between 80MHz and 700MHz under an electric field level of 10 V / m, resulting in a temporary loss of function, self-recoverable, according to performance criterion C of the Standard.*

Directive 2014/68/EU on pressure equipment (UK Pressure Equipment (Safety) Regulations 2016)

UNE EN 809:1999 +A1 (BS EN 809:1998 +A1:2009)

Directive 2014/35/EU on electrical safety (UK Electrical Equipment (Safety) Regulations 2016)

UNE EN 60204-1:2019 (BS EN 60204-1:2018)

Directive 2003/10/EC on noise level (UK The Control of Noise at Work Regulations 2005)

UNE EN ISO 3740 (BS EN ISO 3740:2019)

UNE EN ISO 3746 (BS EN ISO 3746:2010)



Service Manual

Directive 2011/65/EU on the restriction of the use of certain hazardous substances in electrical and electronic equipment with amendment 2015/863/EU (UK The Restriction of the Use of Certain Hazardous Substances in Electrical and Electronic Equipment Regulations 2012)

Directive 2012/19/EU on waste electrical and electronic equipment (UK The Waste Electrical and Electronic Equipment Regulations 2013)

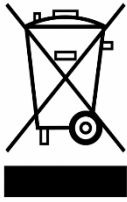

Electrical products cannot be thrown out with the rubbish. They must be taken to a dedicated collection point for an environmentally sound disposal in accordance with local regulations. You must contact your local collective or retailer for information about recycling. Before leaving WEEE at appropriate collection facilities, batteries must be removed and disposed of separately for proper recycling. The packaging materials are recyclable. Dispose of packaging materials in an environmentally sound manner and place them at the disposal of recycling sectors.

TRANSPORT AND STORAGE

Proper precautions must be taken so that the equipment can withstand the effects of transport and storage temperatures between -25°C and +55°C or up to +70°C for short periods that do not exceed 24 hours. Also, appropriate means to prevent damage from moisture, vibrations or shocks must be foreseen.

This chapter contains information on the safety, handling and use of the **G-Connect** series metering unit.



Before installing the unit and starting it up, carefully read all the technical and safety documentation included in this manual. Pay special attention to the information to know and understand the operation and the conditions of use of the unit. All of the information is aimed at enhancing User Safety and avoiding possible breakdowns derived from the incorrect use of the unit.

¡WARNING! Establishes information to alert on a situation that might cause serious injuries if the instructions are not followed.

¡PRECAUTION! Establishes information that indicates how to avoid damage to the unit or how to avoid a situation that could cause minor injuries.

NOTE: is relevant information on a procedure being carried out.

Careful study of this manual will enable the operator to know the characteristics of the unit and the operating procedures. By following the instructions and recommendations contained herein, you will reduce the potential risk of accidents in the installation, use or maintenance of the unit; you will provide a better opportunity for incident-free operation for a longer time, greater output and the possibility of detecting and resolving problems fast and simply.

Keep this Service Manual for future consultation of useful information at all times. If you lose this manual, ask for a new copy from your **HI-TECH** local distributor or directly contact **HI-TECH SPRAY EQUIPMENT**.

¡WARNING! The design of the G-Connect and G-Connect+ dosing units does not allow it to be used in potentially explosive atmospheres or to exceed the pressure and temperature limits described in the technical specifications of this manual.



When working with the unit, it is recommended that the operator wear suitable clothing and elements of personal protection, including, without limitation, gloves, protective goggles, safety footwear and face masks. Use breathing equipment when working with the machine in enclosed spaces or in areas with insufficient ventilation. The introduction and follow-up of safety measures must not be limited to those described in this manual. Before starting up the machine, a comprehensive analysis must be made of the risks derived from the products to be dispensed, the type of application and the working environment



To prevent all possible bodily harm caused by incorrect handling of the raw materials and solvents used in the process, carefully read the safety information provided by your supplier.

Deal with the waste caused according to current regulations.



Disconnect the unit from the power supply before carrying out any operation inside the electrical console.

The electrical maintenance of the machine must only be performed by a qualified electrician.



To avoid damage caused by the impact of pressurized fluids, do not open any connection or perform maintenance work on components subject to pressure until the pressure has been completely eliminated.



Use suitable protection when operating, maintaining or remaining in the operating area of the unit. This includes, but is not limited to, the use of masks, protective goggles, gloves, shoes and safety clothing.

The unit includes components that reach temperatures that are liable to cause burns. The hot parts of the unit must not be handled until they have cooled.



To prevent serious harm by crushing or loss of limbs, do not work with the unit without the safety guards installed on all moving parts. Make sure that all of the safety protections are correctly reinstalled after all repair or maintenance work is completed.



CHARACTERISTICS

The **G-Connect** & **G-Connect+** metering unit has been designed and built for the application of Polyureas, chemical systems for polyurethane foaming and some two-component epoxy systems.

Principal Heating System

Consists of two independent heaters without seals. Each heater has four heating elements (1500 W or 2000 W), that give the unit a total power of 6000 W or 8000 W, and the necessary control and safety components for precise operation of the system. Its singular configuration allows a temperature differential (ΔT) of 90° F and application temperatures of up to 194° F under normal conditions of ambient temperature.

Hose Heating System

G-Connect & **G-Connect+** has designed with a 4000 W isolation transformer that enables effective heating up to a total hose length of 93 m for polyurea and foam. The system includes an innovative hose heating concept in which the copper heating element is spread evenly around the circumference of the hose, providing a uniform heating watt density and precise control of the product application temperature. This hose heating element design is extremely resistant to fatigue failure.

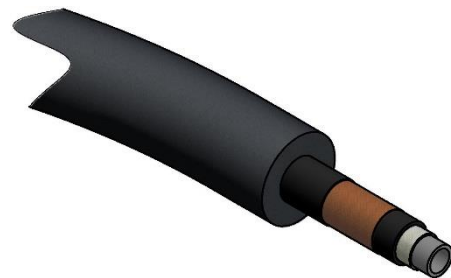

100% circumferential coverage produces the most homogenous distribution of heat available.

Double Acting Opposed Piston Metering Pumps

A pump line driven by a double rod hydraulic cylinder. The in-line pump system with opposed piston pumps provides a constant volume and guarantees uniform pressures in both directions of pump movement. Different sized pumps allow for various volumetric ratios to be achieved (1:4 to 4:1) between the chemical components used in the process.

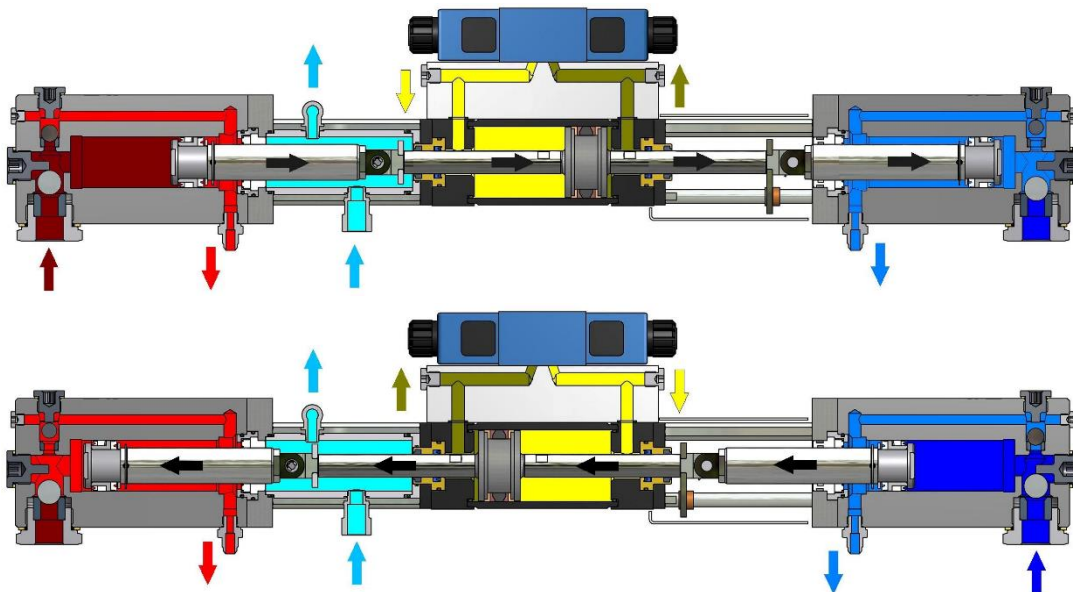



TECHNICAL SPECIFICATIONS “G-CONNECT”

Electrical

Main voltage: _____ 400 V
Frequency: _____ 50/60 Hz
Electrical consumption: _____ 38.5 A @ 3PE~400 V
Pre Heater power: _____ (2 x 6 kW) 12 kW
Hose Transformer Power: _____ 4 kW
Electrical Motor Power: _____ 4 kW
Total Active Power: _____ 20 kW



Inside the console, there is a terminal strip for connecting the main power (wire not supplied) to the unit. The electrical connection of the unit must only be carried out by a qualified electrician.

Mechanical

Maximum working pressure P1 (with pumps 1.2): _____ 240 bar (24 MPa)
Max. Production ratio 1:1 (with pumps 1.2): _____ 15 kg/min @ 110 bar (11 MPa)
_____ 9 kg/min @ 160 bar (16 MPa)
_____ 7 kg/min @ 240 bar (24 MPa)
Minimum production: _____ 1 kg/min
Maximum hose length: _____ 93 m
Recommended compressor: _____ 3 HP III phase

Acoustic

A-weighted sound pressure level: _____ 78,3 dB (A)
A-weighted sound power level: _____ 93,4 dB (A)

Values obtained according to UNE-EN ISO 3746:1995 standard.

Approximate weight (hudraulic tank empty): _____ 242 kg
Approximate weight (hydraulic tank full): _____ 270 kg
Dimensions: _____ H: 1295 mm / W: 745 mm / L: 650 mm

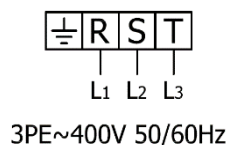



TECHNICAL SPECIFICATIONS “G-CONNECT+”

Electrical

Main voltage: _____ 400 V
Frequency: _____ 50/60 Hz
Electrical consumption: _____ 51 A @ 3PE~400 V
Pre Heater power: _____ (2 x 8 kW) 16 kW
Hose Transformer Power: _____ 4 kW
Electrical Motor Power: _____ 5.5 kW
Total Active Power: _____ 25.5 kW



Inside the console, there is a terminal strip for connecting the main power (wire not supplied) to the unit. The electrical connection of the unit must only be carried out by a qualified electrician.

Mechanical

Maximum working pressure P1 (with pumps 1.2): _____ 240 bar (24 MPa)
Max. Production ratio 1:1 (with pumps 1.2): _____ 22 kg/min @ 110 bar (11 MPa)
_____ 17 kg/min @ 160 bar (16 MPa)
_____ 12 kg/min @ 240 bar (24 MPa)
Minimum production: _____ 1 kg/min
Maximum hose length: _____ 93 m
Recommended compressor: _____ 3 HP III phase

Acoustic

A-weighted sound pressure level: _____ 78.4 dB
A-weighted sound power level: _____ 93.5 dB

Values obtained according to UNE-EN ISO 3746:1995 standard.

Approximate weight (hydraulic tank empty): _____ 260 kg
Approximate weight (hydraulic tank full): _____ 288 kg
Dimensions: _____ H: 1295 mm / W: 745 mm / L: 650 mm

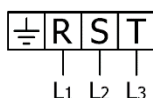

3PE~400V 50/60Hz



GENERAL DESCRIPTION

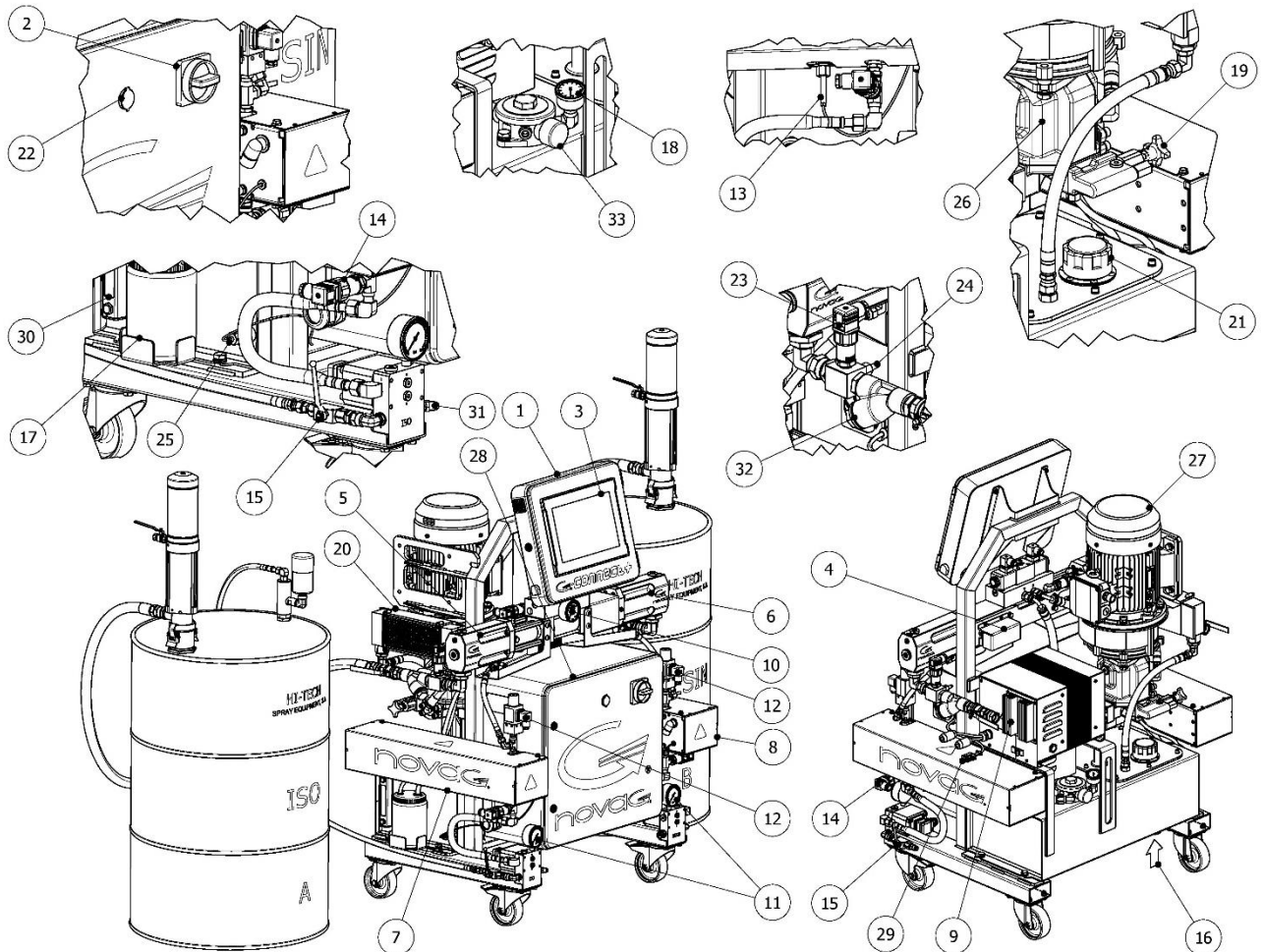

Figure 1. General Description.

1. Console Control

Incorporating the 12.1" touch screen.

2. Power Switch

Connects and disconnects the power supply to the electrical cabinet. It must be connected (**ON** position) to be able to perform any operation with the equipment. When in **ON** position, the touch screen will light up.

3. Touch Screen

From different screens and sub screens, the required parameters can be settled, as also select some different systems and view breakdown and functional data saved during the projection.



Service Manual

4. Reverse Switch

They activate the change of direction of the product pump delivery direction.

5. Isocyanate Dosing Pump

Provides isocyanate to the system.

6. Polyol Dosing Pump

Provides Polyol to the system.

7. Isocyanate Heater

Heat the isocyanate to the pre-set temperature.

8. Polyol Heater

Heat the Polyol to the pre-set temperature.

9. Transformer Heating Hoses

It supplies the voltage required for heating the hoses.

10. Hydraulic Pressure Gauge

Indicates the pressure of the hydraulic circuit.

11. Pressure Gauge of each Product

Indicates the pressure in the product circuits.

12. Safety Pressure Switch for each Product

Deactivates the hydraulic solenoid valve in case of excess pressure in the corresponding product circuit.

13. TCS of each Product

Provides independent temperature information on each Product (Temperature Control Sensor).

14. Pressure Transducer of each Product

Read the output pressure in each product circuit.

15. Recirculation Valve for each Product

Opens or closes the independent passage of each product for recirculation from the heater outlet.

16. Oil Tank Drain Plug

By removing the plug, the oil tank can be emptied.

17. Lube Reservoir

Specific lubricant tank for the closed lubrication circuit of the isocyanate pump shaft.

18. Return Filter Obstruction Indicator

Hydraulic oil circuit return filter sealing level indicator.

19. Hydraulic Pressure Regulator

Allows you to increase or decrease the pressure of the hydraulic system. To increase the pressure, turn clockwise and to decrease the pressure turn counter clockwise. To be able to regulate the pressure of the hydraulic system, the hydraulic pump must be activated.



Regulate the hydraulic system so that the output pressure of the unit never exceeds the pressure of work of the installed product hoses



20. Radiator Hydraulic oil

Hydraulic oil circuit cooling unit.

21. Filler Cap

Hydraulic oil tank filler neck.

22. Ethernet Port

RJ45 Ethernet port for optional Wi-Fi router connection. This connection includes 24V power supply.

23. Inlet pressure transducer for each Product

Device for reading the inlet pressure of each Product.

24. Inlet TCS for each Product

Device for reading the inlet temperature of each Product.

25. TCS Oil Tank

Device for reading the oil temperature at the tank outlet.

26. Hydraulic Pump

Variable flow hydraulic oil pressure supply unit.

27. Motor

Power supply unit for the hydraulic pump.

28. Electrical Cabinet

It contains all the electrical components that control and regulate the correct operation of the unit.

29. Connector TCS Hoses

Connector for the Isocyanate (and optionally Polyol) temperature measuring device at the end of the product hose.

30. Oil Sight Glass Tank

Hydraulic oil level and temperature sighting device in the tank.

31. Product Output

Location of the threaded connections to join the product hoses.

32. Inlet Product Filters

Devices located at the inlet of each product that limit the entry of impurities according to the mesh size.

33. Hydraulic Return Filter

It filters the impurities generated in the hydraulic circuit. By means of the sight glass (18) it is possible to control its sealing level clogging condition.



TOUCH SCREEN

The **G-Connect** and **G-Connect+** dosing units are equipped with an TFT LCD display for the configuration and control of the unit. Through this device you can interact both to configure the unit and to operate it.

Description of the Screens

The different screens for interaction with the machine are divided into; the **DISPLAY AND OPERATION AREA** (central area **A**) and the **MAIN BAR** (upper band **B**), see. **Figure 2**.



Figure 2. Screen “HOME”.

The content of the display and operation area **A**, varies according to the active screen in the main menu.

The main screen for operation in manual mode is called "**HOME**" and from this screen all the basic operations of the unit can be performed.

From the different blocks of this screen the machine can be operated without the need to access another menu. This facilitates the user's experience and enables them to quickly acquire the necessary knowledge to operate the equipment.



Description of the Machine Product Control Areas



This area independently controls everything related to the products at the outlet of the machine heaters, both isocyanate and polyol. Both areas include:

1. **HEATER OPERATION:** Pressing the icon , the corresponding ISO/POL heater is switched on or off. If red, the heater is switched off. If green, the heater is on.
2. **HEATER TEMPERATURE CONTROL:** Shows the current temperature of the corresponding product, as well as the programmed set point. Pressing on this, a window appears that allows to modify it independently for each product.
3. **PRESSURE CONTROL:** Displays the current pressure value of the corresponding product. By pressing on it, you can modify the corresponding minimum and maximum pressure values for each alarm, as well as turn it on and off.
4. **FLOW CONTROL:** Displays the flow rate for each product, if flow meters are installed.



Description of the Hose Product Control Area

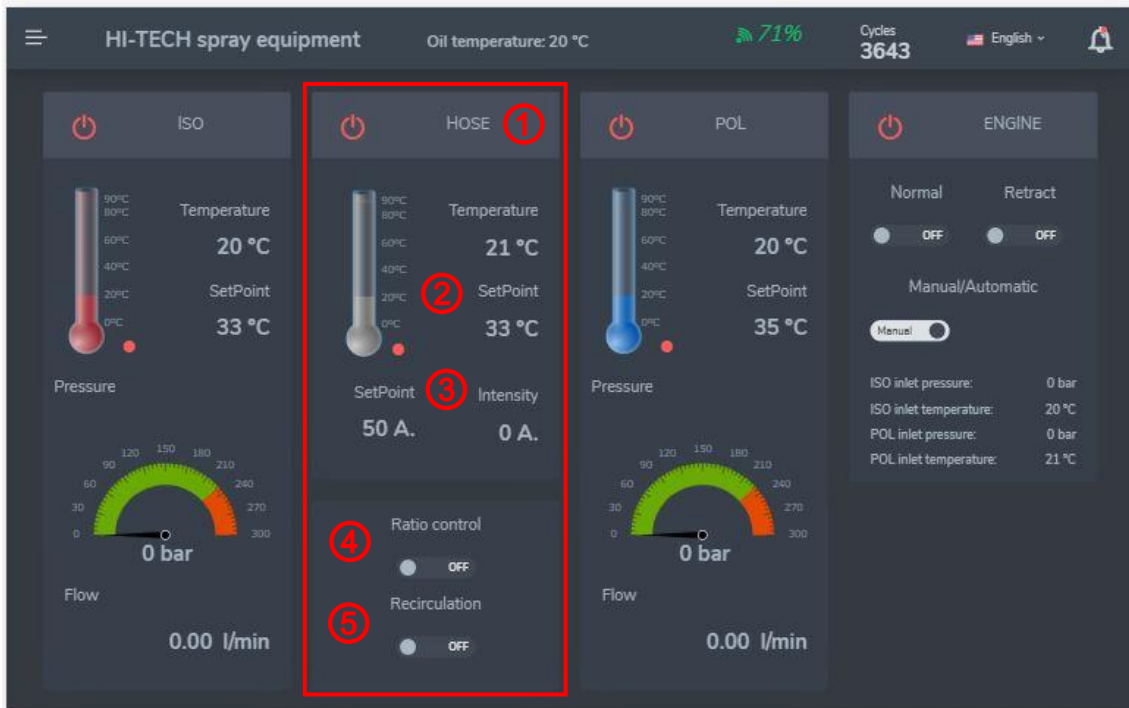

From this area the parameters for the temperature control of the products in the hoses are controlled and displayed, as well as the ratio control and recirculation can be operated.

1. **HOSE OPERATION:** Pressing on the icon , if it is red, the hose heating is on or off. If it is red, the hose is off. If green, the hose is on.
2. **HOSE TEMPERATURE CONTROL:** Displays the current value of the product in which the temperature probe is installed (by default in the ISO hose), as well as the programmed set point. Pressing on this, a window appears allowing to modify its value.
3. **AMPERAGE CONTROL:** This block displays the current amperage in the hose and the setpoint value by which the maximum current flowing through the transformer can be limited.

Refer to the values indicated in the table below to select the intensity value that allows reaching the required application temperature:

30 A	38° C	100° F
35 A	48° C	118° F
40 A	60° C	140° F
45 A	75° C	167° F
50 A	80° C	176° F

Select the required amperes for fast preheating.



In manual mode, if a current higher than 35 amps has been selected, after 20 minutes, the current will automatically adjust to 35 amps.

This intensity cannot be changed above 35 amps until the heating is disconnected from the hoses and reconnected.

The setpoint programmed by the machine operator will be stored for the next heating start-up.

- 4. **RATIO CONTROL:** Activates/deactivates the function. Controls that the pressure difference between the components does not exceed the programmed value through the PARAMETERS 1 - Control Ratio screen (between 0 and 25%). If the difference is greater, an alarm will be activated. The pressure difference control system is activated after pressing the NORMAL key and after the seconds selected through the screen PARAMETERS 1 - Ratio Control Delay (between 0 and 10 seconds) and allows to remain out of ratio during this time before activating the alarm. The ratio control function is memorized.
- 5. **RECIRCULATION:** Activates/deactivates this operating mode for when the machine is turned on.

Description of the Control Unit Area (Manual mode)





Service Manual

This area controls the motor, the movement of the pumps and displays the pressure and temperature values of both products at the machine inlet.

1. **OPERATION:** Pressing the symbol , the engine is started/stopped. If red, the motor is stopped. In green color, the motor is running.
2. **NORMAL/RETRACT:** From these markers, the displacement of the product pumps is displayed and the movement of the product pumps is controlled.
3. **MANUAL/AUTOMATIC:** This switch is used to switch between manual and automatic mode.
4. **INPUT PARAMETERS:** This area displays the pressure and temperature values of each product at the machine inlet, if the corresponding sensors are installed

Area Description Control Unit (Automatic mode)

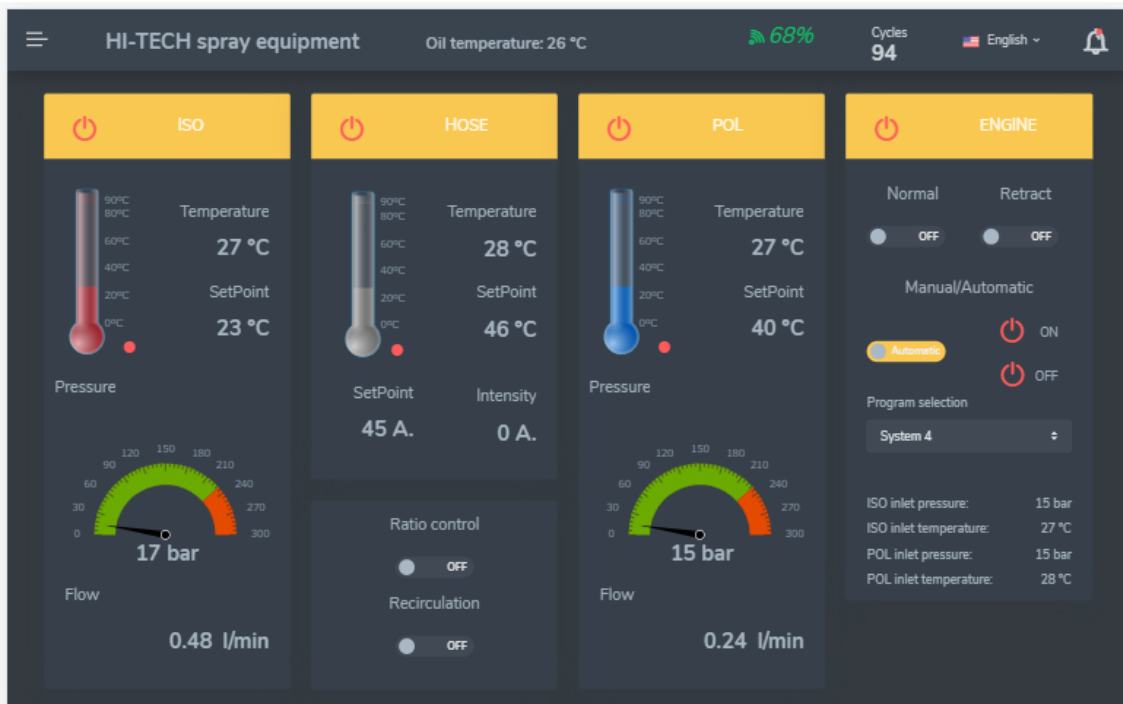

Switching the system to AUTOMATIC mode will control the sequential ignition of the machine following the parameters pre-set in the different **SYSTEMS**.

1. **AUTOMATIC ON/OFF:** these push buttons are used to turn the system on or off in automatic mode. They are the only control parameters that are enabled in this mode.
2. **PROGRAM SELECTION:** from this drop-down menu the preset system can be selected. The **SYSTEMS** can be edited from the corresponding screen by accessing from the main menu.



Main Bar Description

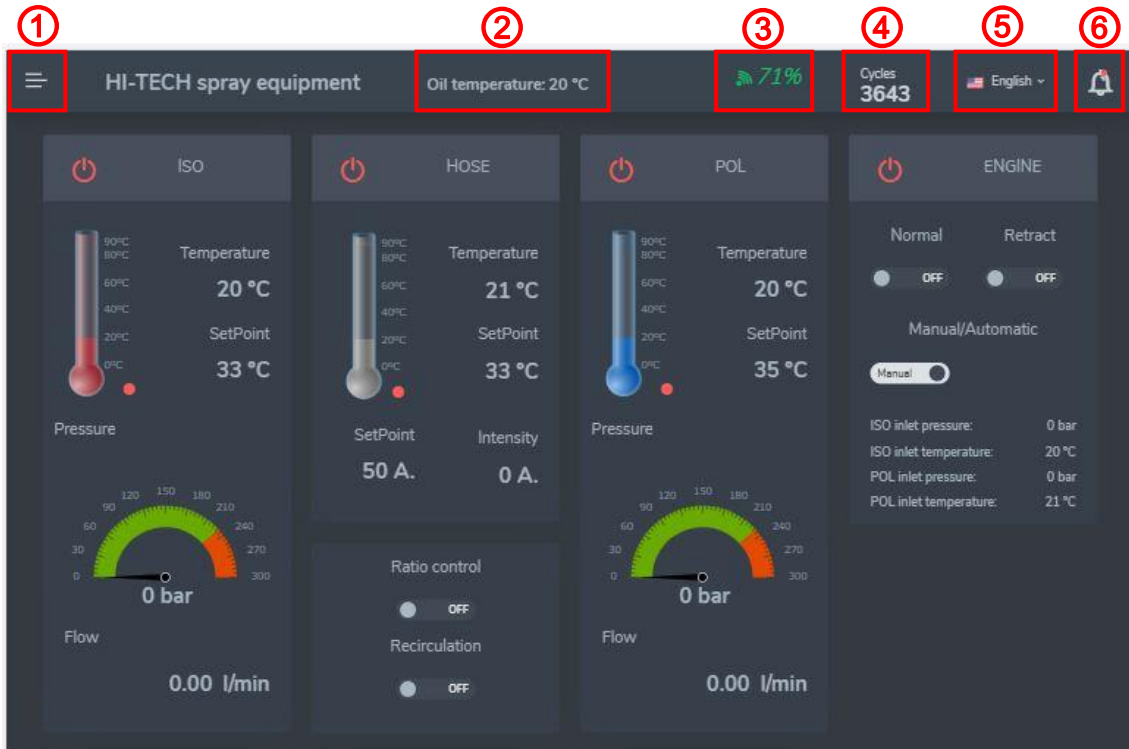

The **Main Bar** is composed of:

1. Access to the Main Menu.
2. Hydraulic oil temperature Reading.
3. SIM Coverage.
4. Total Cycles Performed (since the last reset).
5. Language settings.
6. Indicator and access Alarms.



Main Menu



By clicking on the **Main Menu** button on the bar, a drop-down menu appears which will be used to access the screens with the different options offered by the machine.

HOME

This is the main general control screen of the unit (see **Figure 2**). It can operate in manual or automatic mode.



PARAMETERS

In this screen, you can configure the machine parameters (in the Parameters 1 tab) and the characteristics of each product (in the Parameters 2 tab).

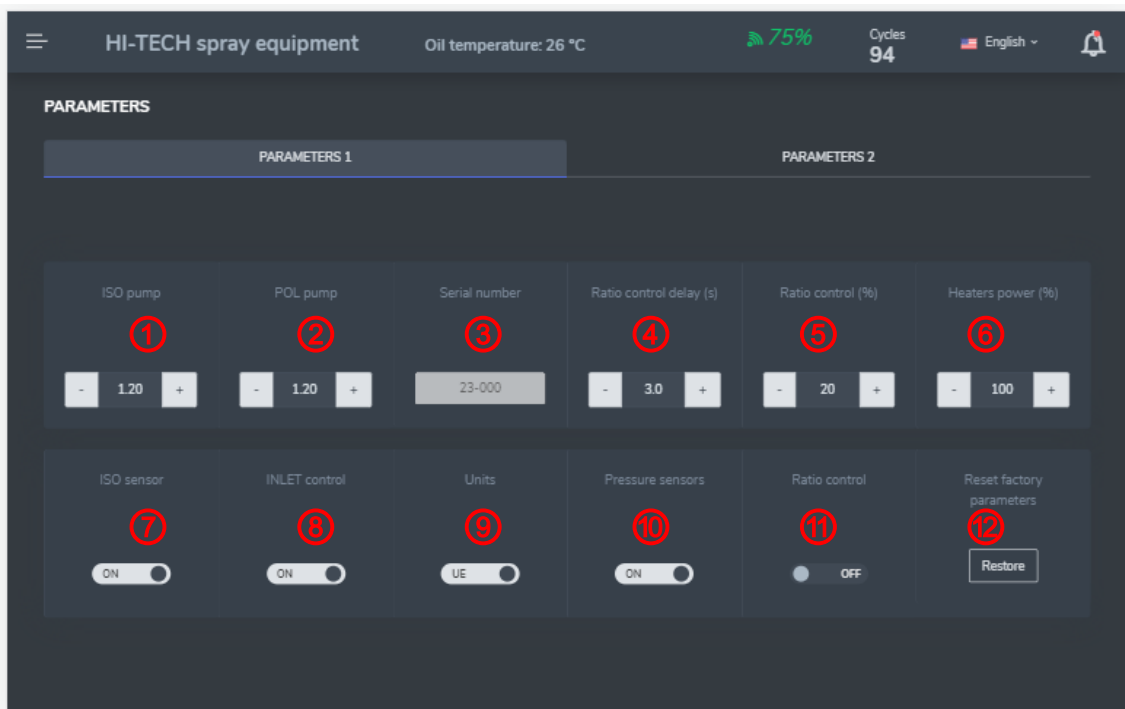

1. ISO pump size configuration. Factory preconfigured value. To be changed if the size of the installed pumps is changed.
2. POL pump size configuration. Factory preconfigured value. To be changed if the size of the installed pumps is changed.
3. Machine serial number. Preconfigured value from the factory and not editable.
4. Delay time for Ratio control (seconds). Editable value from 0 to 10 seconds.
5. Tolerance percentage for Ratio control (%). Editable value between 0 and 25 %.
6. Heater power percentage (%). Editable value to obtain between 50 and 100% of the total power installed in the heaters.
7. Hose probe activation/deactivation.
8. Activation/deactivation of product input sensors. To have pressure and temperature readings in the machine feed.
9. Switching units. To select between metric or imperial system.
10. Activation/deactivation of pressure sensors. Relating to pressure transducers installed on heaters.
11. Ratio control activation/deactivation.
12. Reset to factory settings.

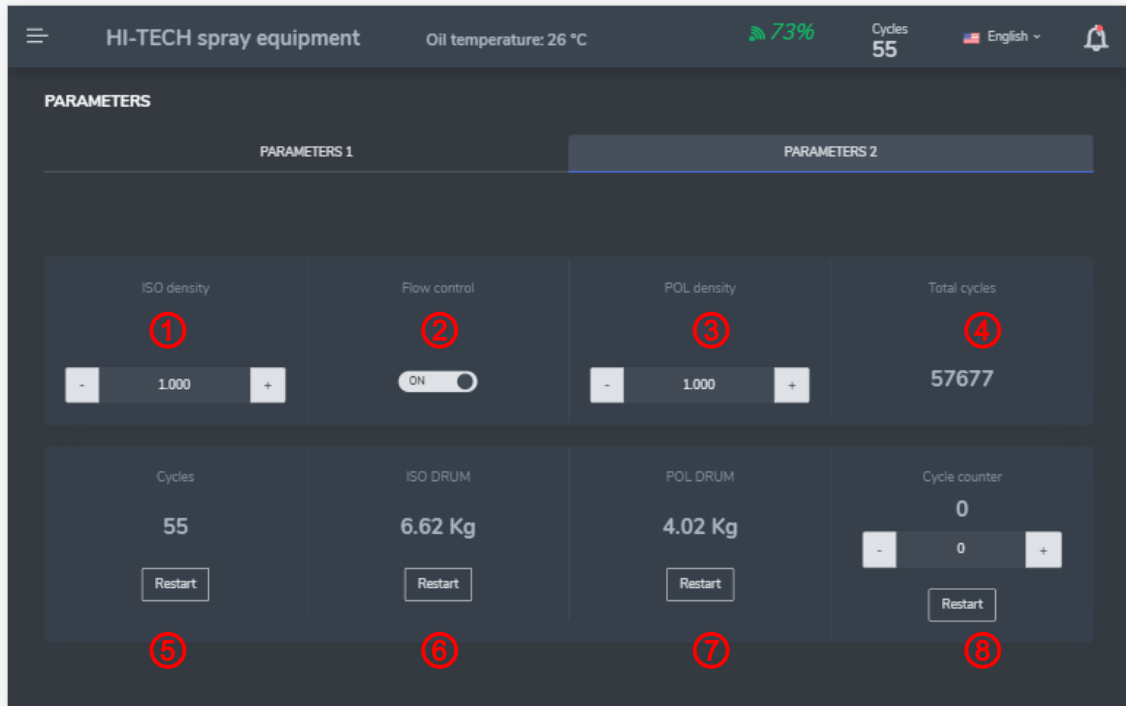

1. ISO density.
2. Activation/deactivation of flow control.
3. POL density.
4. Total machine cycles (cannot be reset to zero).
5. Cycles performed since the last reset. Press "Restart" to reset to zero.
6. Kilograms of ISO product consumed. Press "Restart" to reset to zero.
7. Kilograms of POL product consumed. Press "Restart" to reset to zero.
8. Cycle preselector. A limit of cycles to be consumed can be programmed. Pressing "Restart" resets to the last programmed value.



DOSAGE

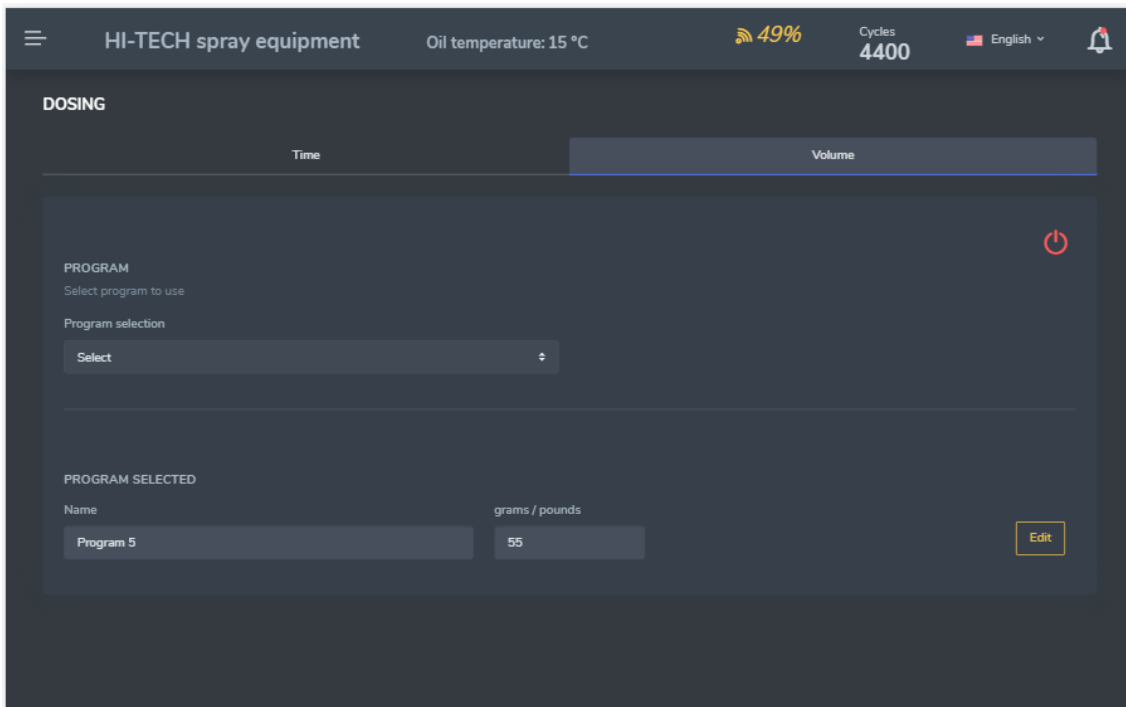
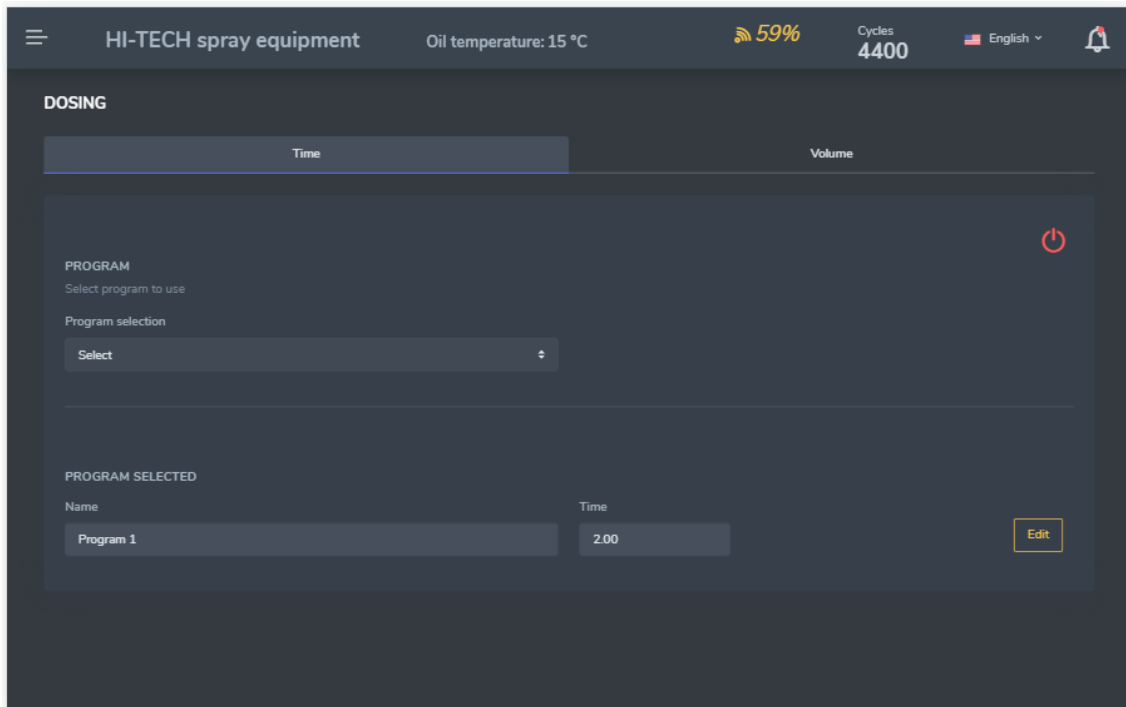

The dosing screen is divided into two tabs; dosing by "Time" and dosing by "Volume". If the flow meters are not installed, or are not activated in the PARAMETERS 2 - Flow Control screen, the DOSAGE screen will only show the option by time.



Service Manual

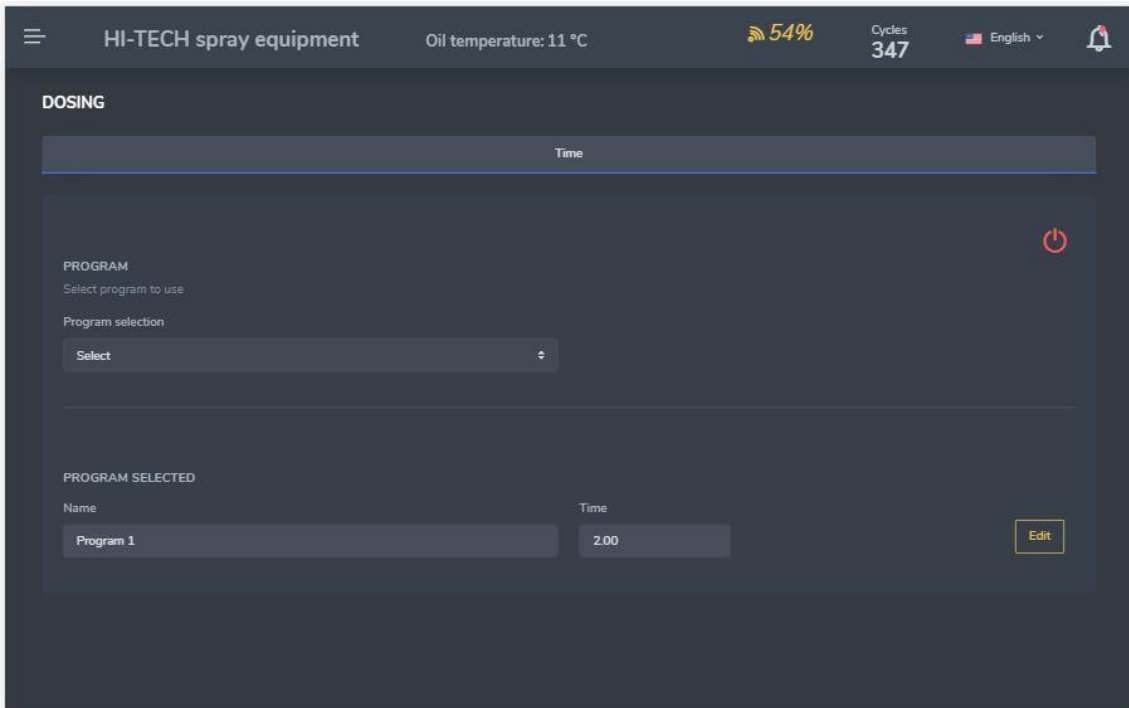

Both the dosing by time and dosing by volume consist of 10 programs each that can be edited. The maximum allowed in the time selection will be 300 s and in the material dosing will be 10 kg.

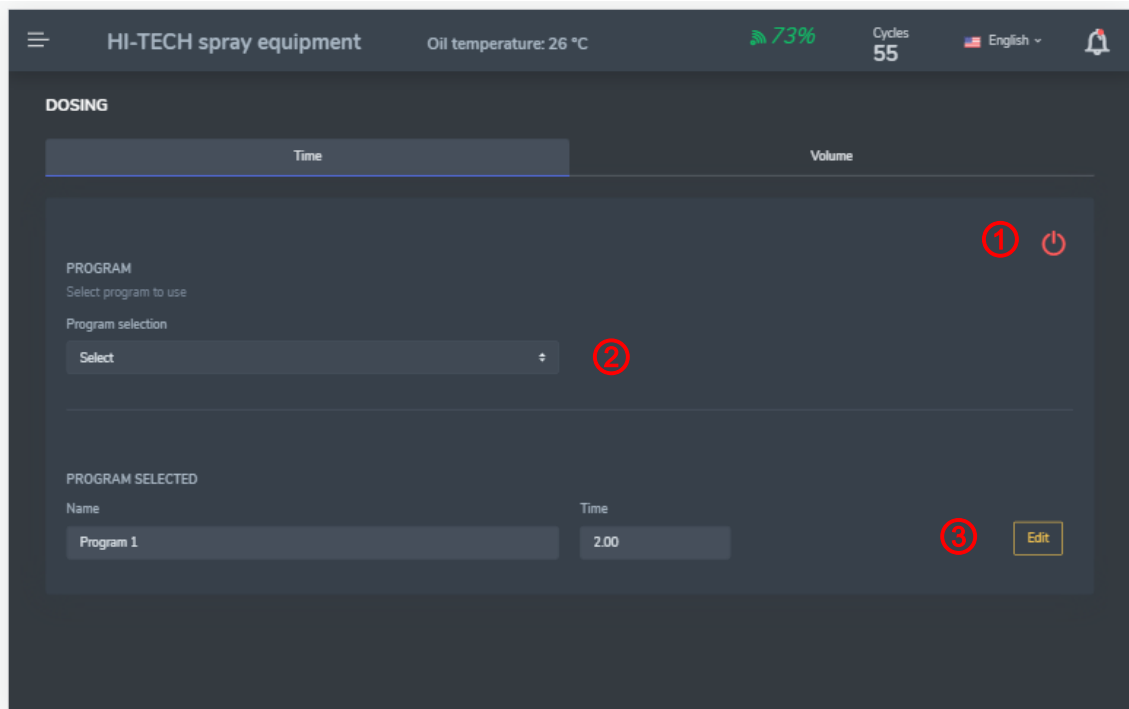



1. Power button: When this button is pressed, it appears green and means that the dosing with the selected program is activated.
2. Program selection bar: In this bar the program for dosing and/or for editing is selected.
3. Edit button: This button is used to edit the selected program.

All parameters in both the time tab and the volume tab are equivalent.



DRUMS

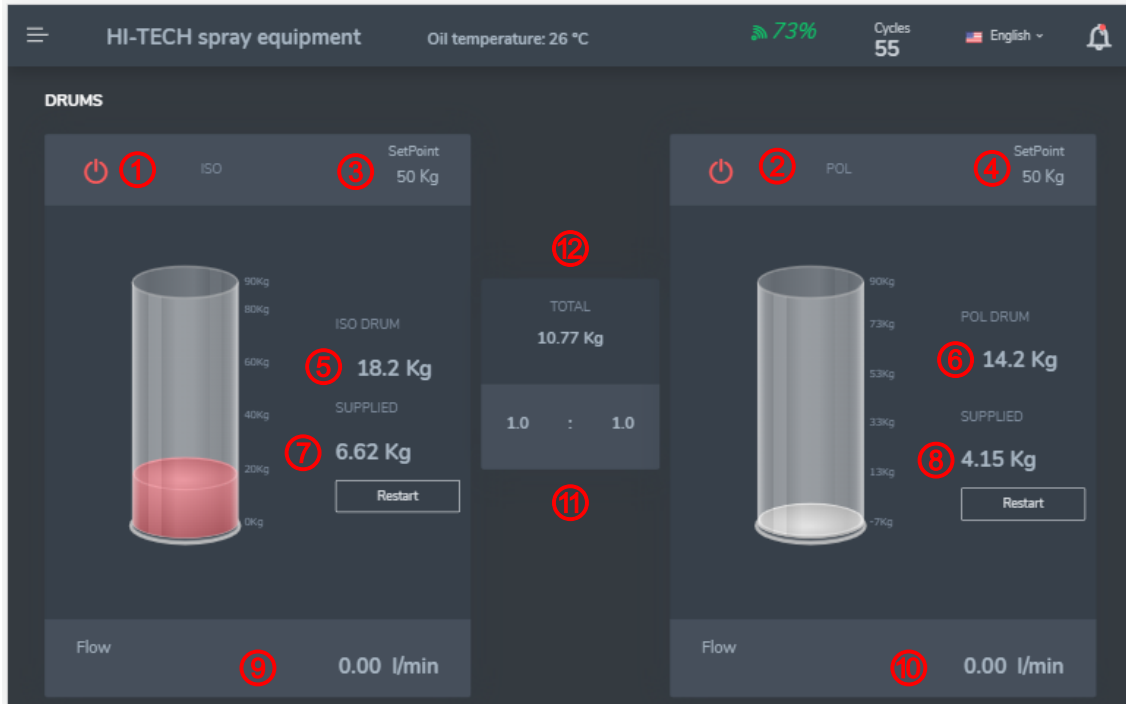

From this screen you can control the material available in the tanks, as well as the ratio and quantity of material dispensed, both individually for each product and in total. If flow meters are installed, the values will be the result of an actual reading. If the machine does not incorporate flow meters, the value obtained will be the one calculated between the number of cycles performed and the size of pumps installed.

1. ISO power button: Activates the material control on the ISO drum.
2. POL power button: Activates the material control on the POL drum.
3. ISO drum capacity: The capacity of the ISO drum must be entered.
4. POL drum capacity: The capacity of the POL drum must be entered.
5. Display of the amount of material remaining in the ISO drum.
6. Display of the amount of material remaining in the POL drum.
7. Display of the quantity of ISO dosed material.
8. Display of the quantity of POL dosed material.
9. Instantaneous Current ISO flow rate display.
10. Instantaneous Current POL flow rate display.
11. ISO/POL RATIO display.
12. Total visualization of projected dosed material (ISO+POL).



SYSTEMS

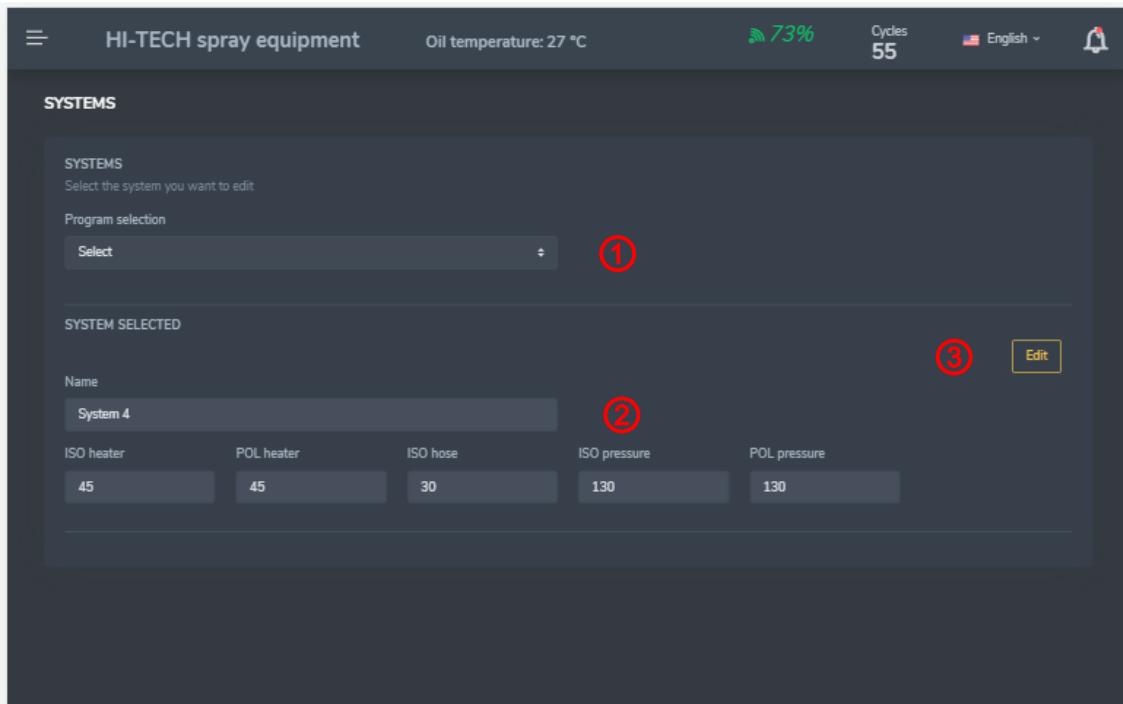

This screen is used to control and edit the SYSTEMS stored to be used in AUTOMATIC mode. It is possible to enter up to 10 different systems.

1. System selection for editing.
2. Information of the selected system.
3. Button to edit the selected system. From this button you can access a secondary screen to edit all the parameters of the system.

Each SYSTEM is composed of five parameters:

ISO Heater	→	ISO product temperature at the heater outlet.
POL Heater	→	ISO product temperature at the heater outlet.
ISO Hose	→	ISO product temperature at the ISO hose.
ISO pressure	→	ISO product pressure at machine outlet.
POL pressure	→	POL product pressure at machine outlet.



GRAPHICS

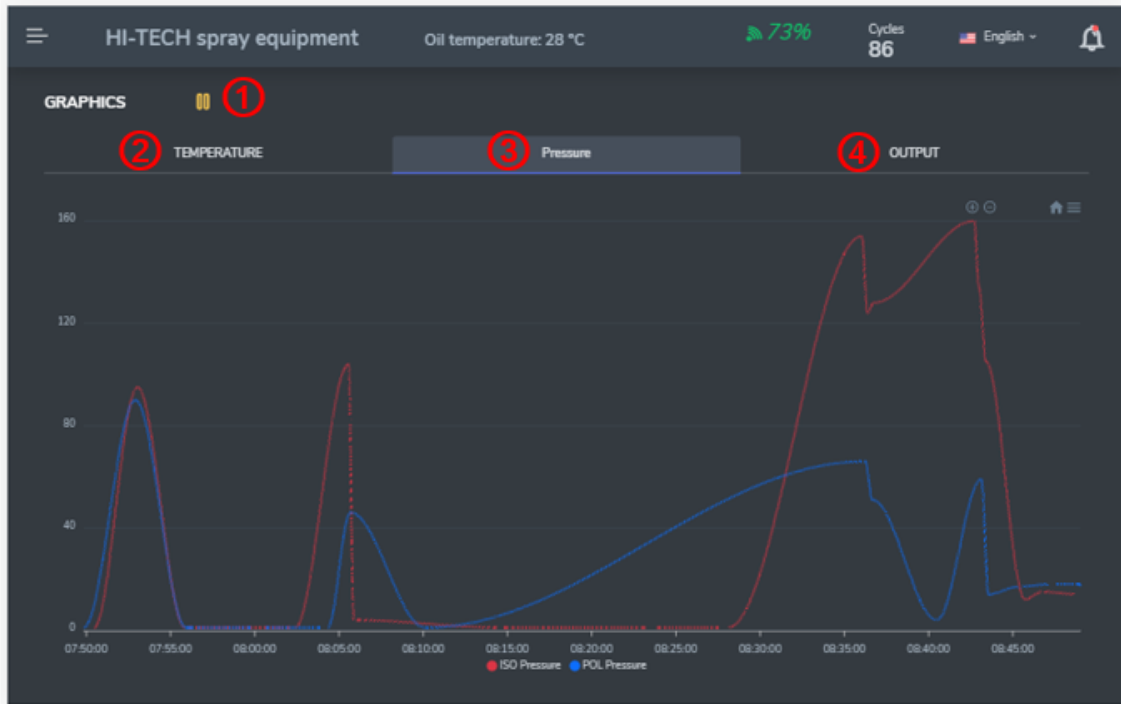

This screen is an instant graphical display of the log curves for each product. The curves for the last hour can be observed. Using the ① button, you can pause the graph and interact over an estimated time range.

The display is divided into three tabs; ② TEMPERATURE, ③ PRESSURE and ④ FLOW.

To check the deviations, you can overlap the log lines with each of their corresponding SetPoint by turning it on or off by clicking on top of each of them in the lower legend of the graph.

If you click on the curve, a window will show the values of that curve together with the SetPoint value and highlighting the existing deviation.



COMMUNICATION

The COMMUNICATION screen is divided into three tabs:

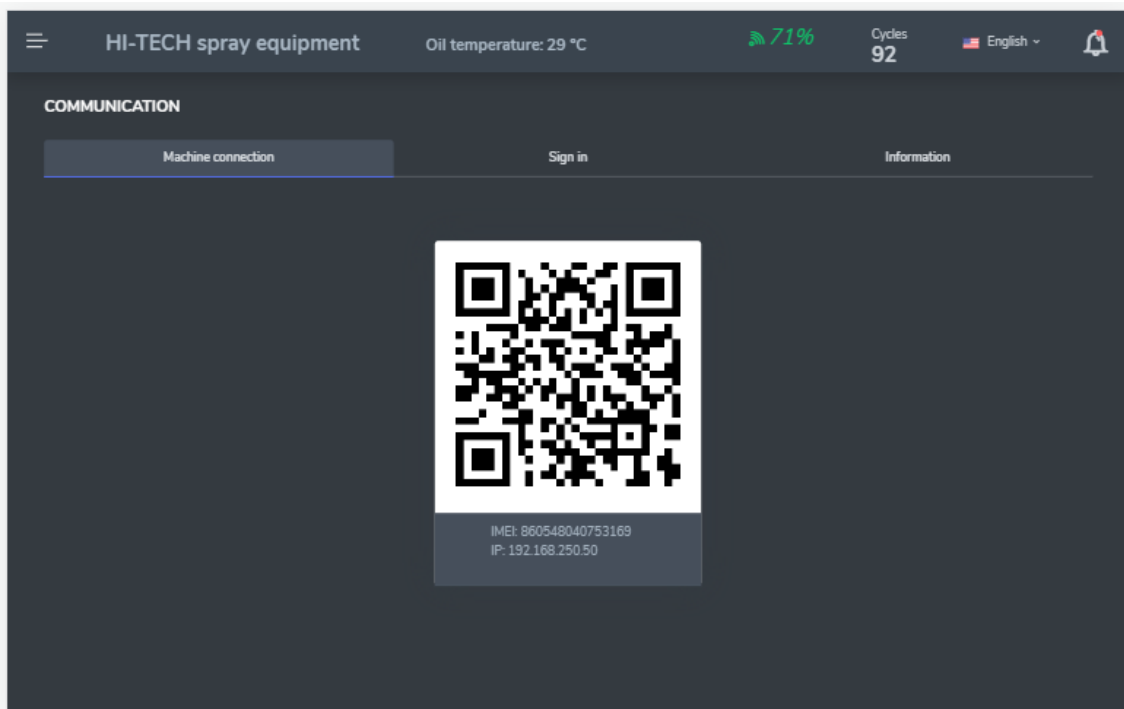

1. CONNECTION WITH THE MACHINE. The machine provides a QR code that is used to register it on the HI-TECH WEB platform.

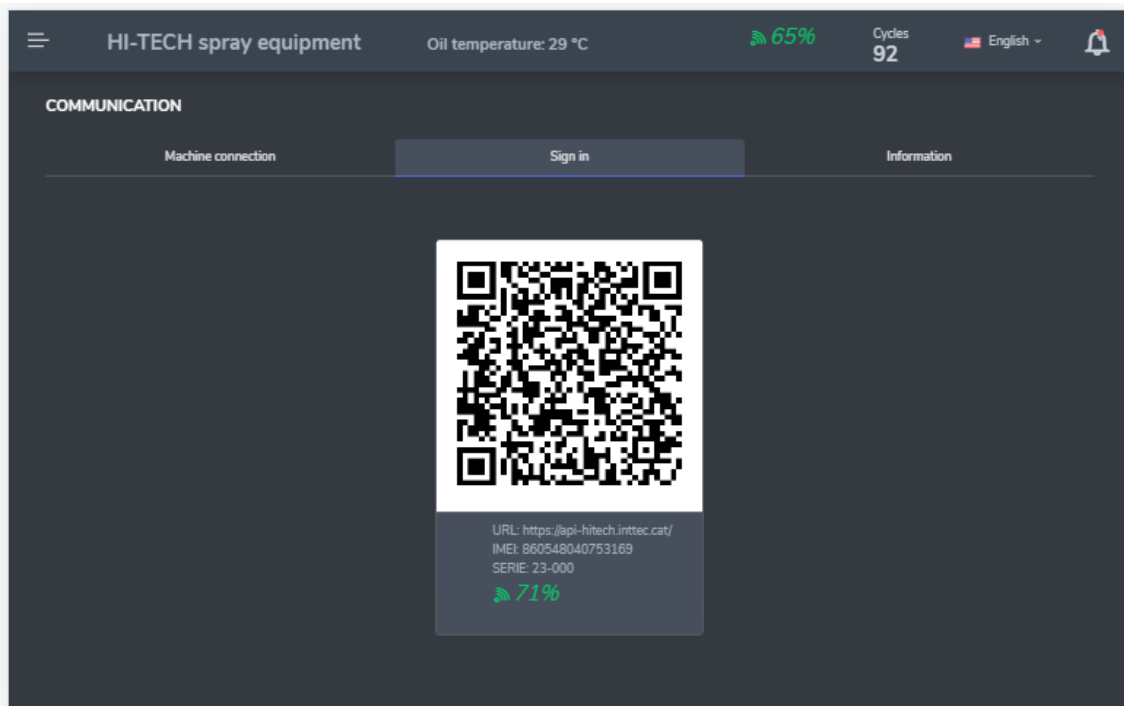



Service Manual

- 2. MACHINE REGISTRATION. By means of this QR the connection between the machine and the HI-TECH APP is established.

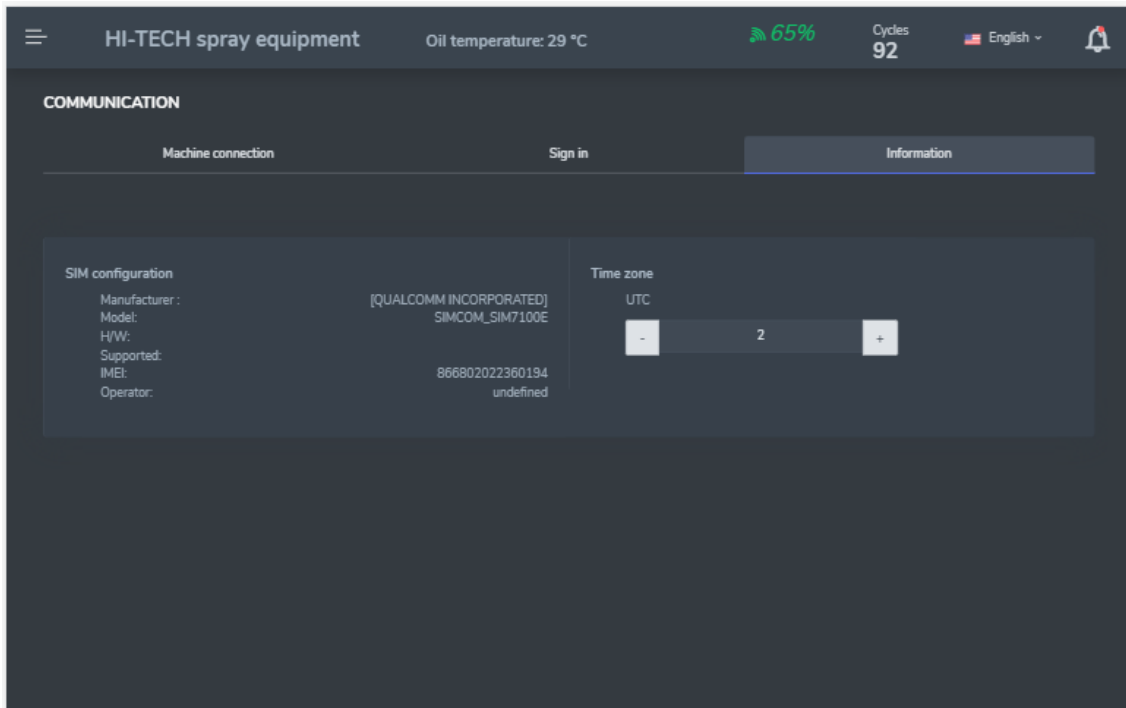

- 3. INFORMATION. This screen is for information. Only the specifications of the machine's connection card are shown.



ALARMS

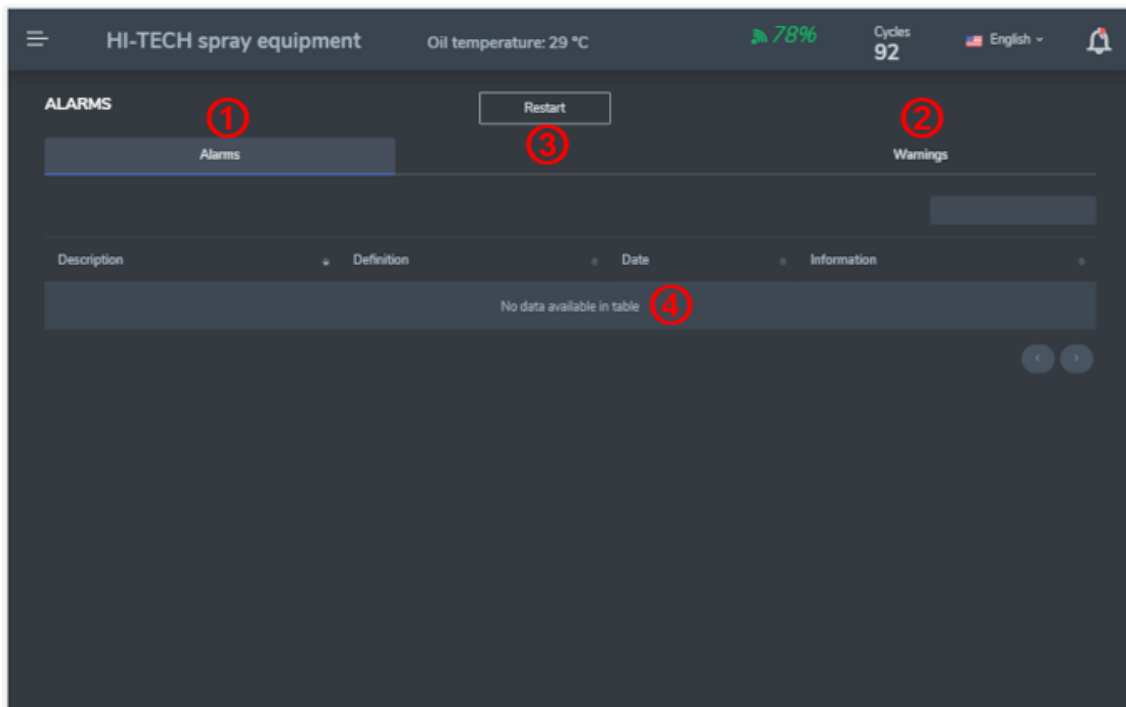

This screen shows all the alarms and warnings that have occurred during the projection. The ALARMS are those incidences that are registered during the projection, are critical for the normal operation of the machine and do not allow to continue with the projection. In these circumstances, the operation of the machine is automatically stopped and cannot be resumed until the anomaly has been resolved by the operator or qualified personnel. WARNINGS are those incidents that are recorded during the projection, are of a minor nature and do not influence the normal operation of the machine, leaving a record of the need for some action by the operator to prevent damage to it.

This screen shows two tabs:

1. ALARMS tab where all the records related to these alarms are displayed.
2. NOTICES tab where all the record related to these appear.
3. RESTART pushbutton for clearing alarm records (after alarms have been resolved) and warnings.
4. List of incidents (both in the Alarms tab and in the Warnings tab, where each incident is detailed and the indications to solve them are given.



Disconnect the unit from the main electric source before handle the internal electric console. The maintenance must be carried out by a qualified electrician.



METHOD OF THREADED UNION OF THE HOSES

Follow the torques for threaded joints listed in **Table 1** according to thread sizes of hose fittings to ensure their proper assembly.

There is also an alternative procedure to obtain an equivalent torque without using special tools: joint both ends of the hoses to be connected, tighten a swivel nut by hand (without using spanner) until there is resistance on the nut. Fit two spanners (1) on the fixed ends of the hoses and turn the swivel nut with a third spanner (2) as many flats from wrench resistance (FFWR) as indicated in **Table 1**.

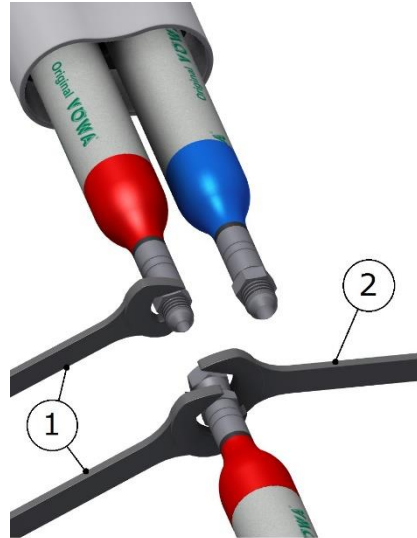
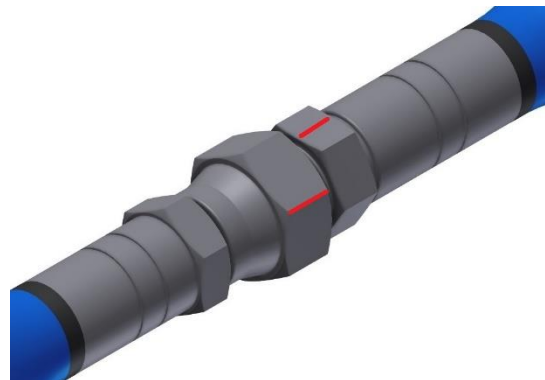

Table 1. Tightening Threaded Joints		
THREAD SIZE	TORQUE Nm	FFWR
1/2"-20	23	2 (o 120°)
9/16"-18	30	1-1/2 (o 90°)

NOTE: 1 FFWR corresponds to one complete shear of a flat marked with red between swivel and fitting or else 60°.





INSTALLATION

!CAUTION! Use appropriate protection and follow the recommendations contained in the safety information provided by the product suppliers when installing or working with the Unit.

HI-TECH provides a series of tools and accessories necessary for assembling the machine. The kit is made up of the following elements:

REFERENCE	DESCRIPTION	QTY.
BI-00009	Tube of grease 1.75 oz./ 49 gr	1x
NR-00049-ENG	Parts Identification Manual	1x
NR-00050-ENG	Service Manual	1x
NR-00023-ENG	Monobloc Pumps Parts Manual	1x
HT-00001	Magnet holder tools	1x
HT-00003	Pin extractor	1x
MA-00102	12” Hoses Connection Cover	2x
EL-00051-00E	ISO TCS Assy with POL extension (For machine with TCS)	1x ①
EM-00012	Hose TCS packaging	1x ①
EL-00093-01	White Flange 300 x 4.8	3x
HT-00045	Allen Key 1/8”	1x
EL-00100-06	Blue Terminal for Cable 16 mm ² L=12mm	2x ①
TN-00242	Threaded Rod 1/4”-20 UNC x 14” nylon	2x ①

① For machines with 1 transformer and TCS (standard versions)



Inside the console there is a terminal strip for connecting the principal electrical wire (not supplied) to the unit. The electrical connection of the unit must only be carried out by a qualified electrician.

NOTE: To ensure correct operation of the Unit the electrical power supply must be able to meet the specifications given on pages 7 and 8 of this manual and on the machine nameplate.



Service Manual

Follow the recommended procedure, in the order given, to install the Unit:

- a) Insert the main power cable through the cable gland at the bottom of the electrical console and make the connection as shown in the diagram.

3 x 400V. 50/60 Hz

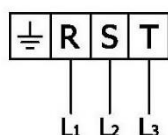

G-Connect+

51,0 A @ 3PE~400V

Cable Section 10 mm²

G-Connect

38,5 A @ 3PE~400V

Cable Section 6 mm²

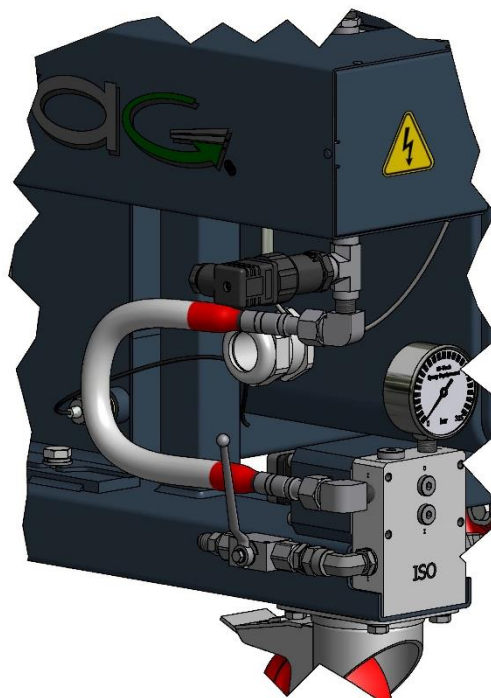

Make sure that the power cable is not connected to the main power supply before connecting it to the terminal located on the console.

- b) Fill 27 liters of hydraulic oil into the unit's reservoir. The oil must comply with the characteristics and specifications of DIN 51524 sections 1 and 2 (e.g. ISO VG 46).

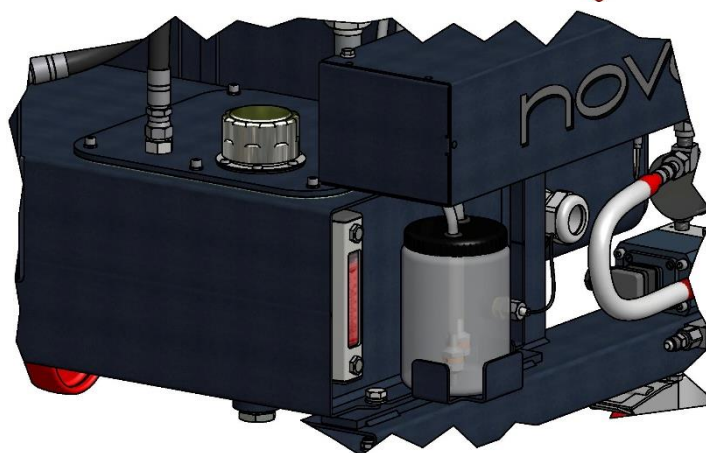

NOTE: Do not fill the tank to its maximum capacity (34 Lts.); verify that the amount of oil introduced does not exceed 80% of the maximum capacity (27 Lts. Approx.). Use the oil thermometer sight glass as a visual reference since the maximum temperature limit (80°C) coincides with the recommended capacity.

- c) Fill the lubrication reservoir of the Isocyanate pump with DOTP. It is not necessary to pre-prime the system.



- d) Connect the product hoses to the respective heater outlets (Isocyanate hose to the Isocyanate heater and Polyol hose to the Polyol heater).

NOTE: The hoses of the products have been differentiated with red color (Isocyanate) and blue color (Polyol), allowing a quick identification of them. To avoid connection errors, the coupling fittings of the Isocyanate and Polyol hoses are of different sizes, which makes it impossible to interchange connections.

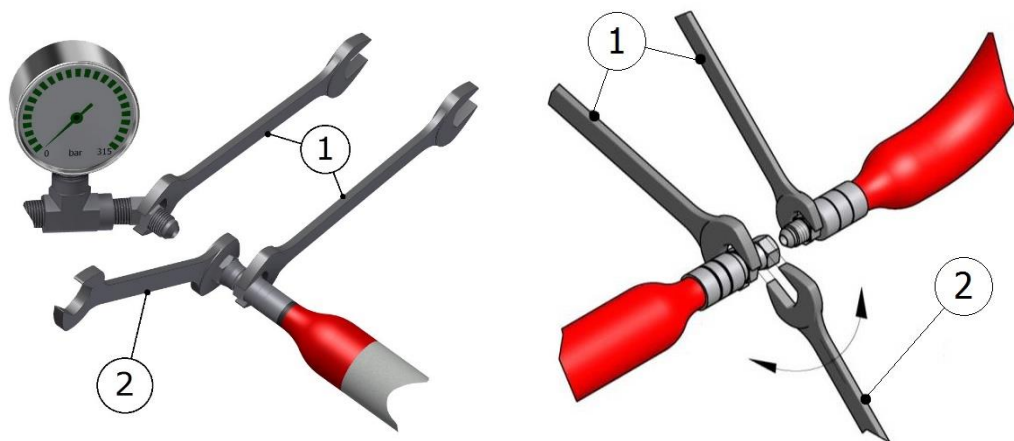

Figure 3. Method of threaded Union for Hoses

¡WARNING! To join the hoses to each other, to the heaters or to the gun, use two wrenches to hold the parts to be joined (1) and with a third wrench tighten or loosen (as appropriate) the union nut (2) as shown in the illustrations. The tightening torque for these joints should be as indicated in the procedure on pag.30.

The hoses are vacuum dried and are supplied interconnected at the ends to protect against moisture absorption. Do not separate them until they are to be installed in the Unit.



Service Manual

The 5 kVA transformer offers the option of connecting to a 45 V output voltage, valid for a total hose length of up to 48 meters, or to a 90 V output voltage, valid for a total hose length of more than 48 meters and up to 93 meters.

Connect to one or the other output voltage depending on the transformer and the total length of hose installed. Before commissioning the unit, check that the connection made at the factory matches the total length of hose installed. If you add or remove lengths of hose make sure that the output voltage of the transformer to which the hose is connected is appropriate to the resulting total length. If not, change the connection.

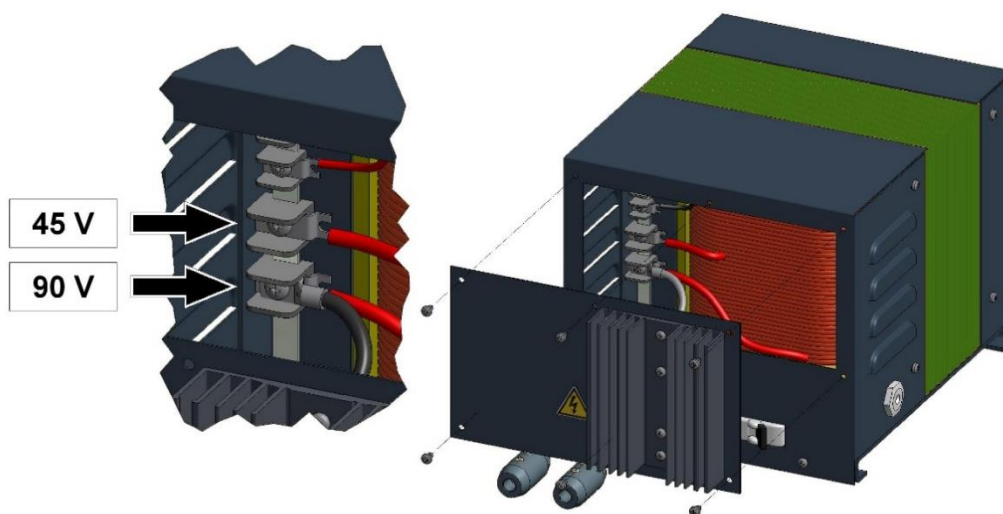

5 kVA			
	MIN.	MAX.	PRODUCT TYPE
45 V	18 m	< 48 m	FOAM/POLIUREA
90 V	> 48 m	< 93 m	FOAM/POLIUREA



The hose connection system incorporates special terminals (fast lock) to facilitate the electrical connection to the transformer and between the different sections installed in the unit.

- e) Connect the electrical cables of the heating system of the product hoses to the fast lock connector body of the transformer output as follows
 - a. Remove the safety caps from the fast lock connector body by unscrewing them.
 - b. Partially unscrew the fixing screws of the electrical cable terminals.
 - c. Insert the electrical wires of the product hoses, with terminals incorporated in the "fast lock" connector body.
 - d. Tighten the fastening screws of the terminals and place the safety plugs.

Repeat the same steps to connect the "fast lock" that you will find in the intermediate connections of the hoses.

- f) Connect the rest of the product hoses until the desired total length is reached. Remember that the hoses are identified with red color (Isocyanate) and blue color (Polyol).

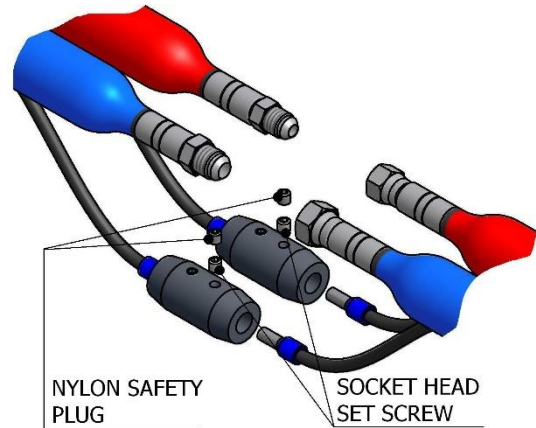

NOTE: Make sure that the mechanical connection and the electrical connection of the hoses are correctly made to avoid possible product leakage and to prevent failures in the heating system.

- g) Install the TCS temperature control probe between the last section of the product hose and the end section connected to the gun. Carefully stretch the probe cable by inserting it into the isocyanate hose on the section coming from the machine.

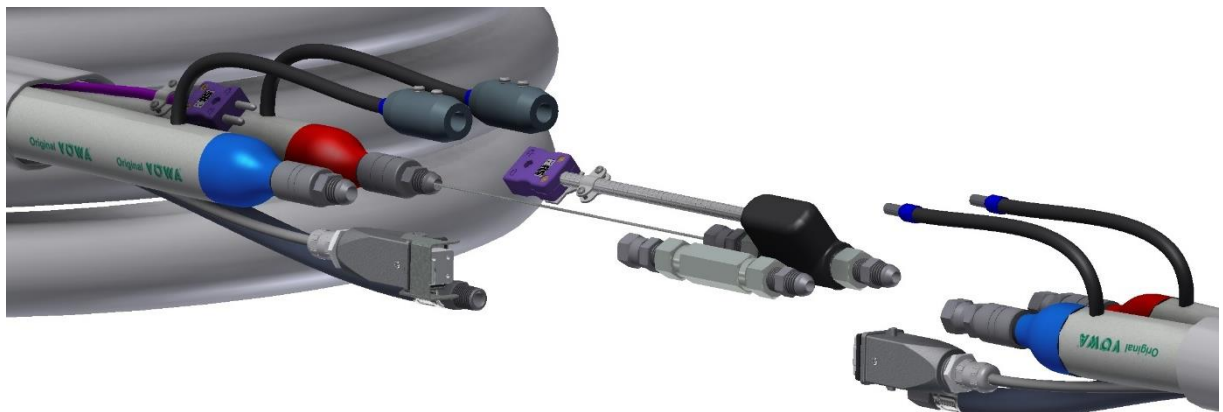



Service Manual

- h) Connect the female electrical connector of the probe to the male connector of the hose. Make as many connections as you have 15 m hose lengths.
- i) To compensate for the increase in length caused by the probe in the ISO hose, place the corresponding extension in the POL hose.
- j) Make the connection between the female connector of the TCS probe cable of the first hose section and the male connector coming from the machine.

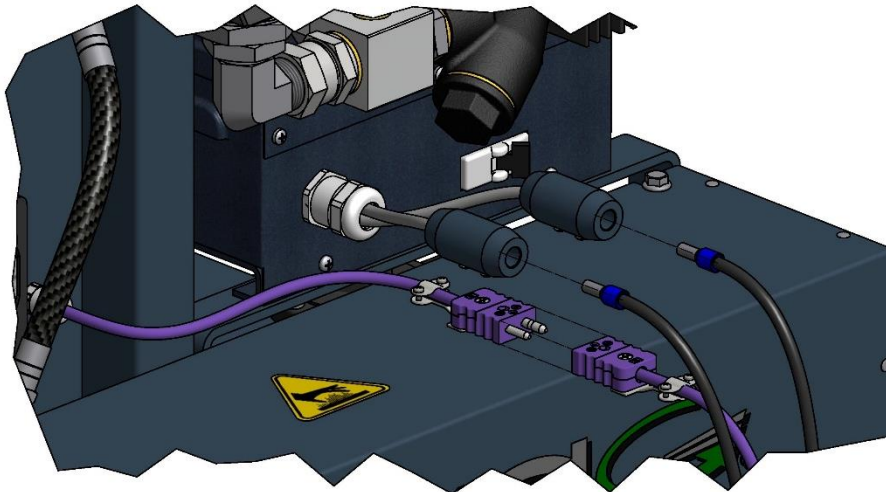

Secure the probe connection with a plastic cable tie by inserting it through the holes of both connectors.

- k) Once the connections have been completed, place the rubber protections for the joints fixing them with three plastic flanges. Subsequently cover the joints with the ends of the hose sleeves.



NOTE: Once the TCS temperature control probe is in place, special care must be taken not to hit or bend the hoses excessively. **DO NOT COIL THE HOSES SO THAT THE RADIUS IS LESS THAN ONE METER.**



- l) Connect the air hoses and gun mic connectors (if applicable).
- m) Connect the hoses to the coupling block fittings of the gun making sure that the manual valves are closed.



Once the operations described above have been carried out, the direction of rotation of the motor must be observed. To check that it rotates in the correct direction perform the following steps:

- a) Turn the hydraulic pressure regulator counterclockwise all the way.
- b) Turn the main switch to ON position. The led on the touch screen will light up.
- c) Position yourself so that you can see the fan on top of the motor . Press the MOTOR key to start the motor and press it again to stop it. Check that the fan blades rotate in the direction indicated by the arrow on the motor label, if not, turn the main switch to OFF and disconnect the machine from the power supply.
- d) Open the control panel console and reposition two of the three wires of the Unit's electrical connection. Recheck the direction of rotation.



Proceed with the installation of the transfer pumps, paying special attention to connect each pump to "its" product, since the interchange of pumps would cause the reaction of the products inside the pumps, rendering them useless. Identifying each pump with a tape of the same color as the hoses (blue for the Polyol pump and red for the Isocyanate pump) can be a good method to avoid connection errors.

To install the pumps perform the following steps:





- a) Make sure that the inlet valves of the products to the Unit are closed.
- b) Connect one end of the Polyol hose to the Polyol stopcock and the other end to the Polyol transfer pump.
- c) Connect one end of the Isocyanate hose to the Isocyanate stopcock and the other end to the Isocyanate transfer pump.
- d) Connect the air hose to the transfer pumps.
- e) Ground the Unit. The velocity of the product inside the hoses can generate static electricity and cause electric shocks.

Before using the equipment, the retained air and the residual oil from the factory tests must be eliminated. To purge the entire circuit, proceed as follows:

- f) Pressurize the transfer pumps and open the product inlet stopcocks. Check for leaks.
- g) Turn the hydraulic pressure regulator counterclockwise all the way.
- h) Turn the main switch to the ON position.



Service Manual





- i) Keep the coupling block with the output of each product in separate containers and open the manual valves of each product of that element.
- j) Press the HYDRAULIC PUMP key  on the manual display, it will change color .
- k) Press the NORMAL key , it will change color .
- l) If necessary, increase the hydraulic pressure by turning the regulator clockwise until the product pumps start to move slowly.
- m) Allow the materials to flow out of the coupling block until the residual oil and air bubbling have completely disappeared.
- n) Close the manual valves of each product of the coupling block and remove the product remains.
- o) Slowly increase the hydraulic pressure to check for product leakage at the hose connections. Retighten if necessary and tape the union fittings to protect them from damage.
- p) Place the gun on the coupling block.



STARTUP METHOD (MANUAL)

Follow the recommended procedure, in the order given, for starting the machine when starting work:

¡CAUTION! *The start-up method described below should be initiated when all necessary pre-settings have been made correctly.*

- a) Check the condition of the DOTP plasticizing oil in the lubrication reservoir of the Isocyanate pump. Change the oil if you observe changes in color or signs of solidification.
- b) Check the hydraulic oil level (see Installation section on pag.31). Add oil if the level is low.
- c) Make sure that the chemicals to be processed are at the minimum temperature required to be supplied to the unit through the transfer pumps. Ask your product supplier for information on what the minimum supply temperature should be.
- d) Check the product inlet filters. Clean them if necessary.
- e) Pressurize the two transfer pumps and open the product inlet valves to the unit.
- f) Turn the main switch to the ON position. The led on the touch screen will light up.
- g) Activate the ISO/POL HOSE TEMPERATURE keys , these will change color  when the temperature has been reached activate the ISO/POL HOSE TEMPERATURE keys , these will change color . A red pilot light indicates when the machine is heating
- h) Set the desired temperature by pressing the +/- keys. With machines incorporating only one transformer select only the ISO amps.

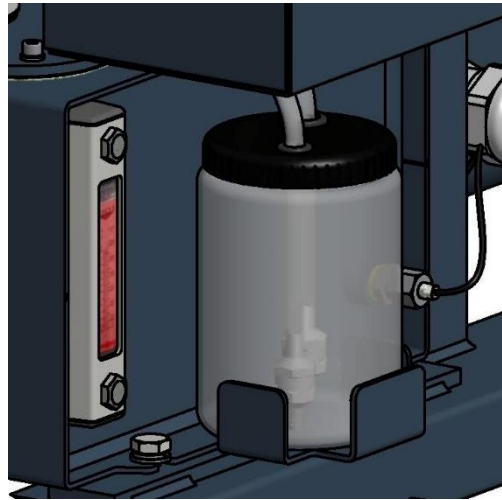







Service Manual

Refer to the values indicated in the table below to select the intensity that allows reaching the required application temperature:

30 A	38° C	100° F
35 A	48° C	118° F
40 A	60° C	140° F
45 A	75° C	167° F
50 A	80° C	176° F

!PRECAUTION! To avoid excess pressure in the heating hoses, wait until the product contained in the hoses reaches the required temperature before starting the hydraulic system.

- i) Press the  HYDRAULIC PUMP key. The key will change color .
- j) Press the  NORMAL key on the manual display. The key will change color .
- k) By means of the hydraulic pressure regulator, adjust the required pressure and check the pressure of each dosing pump on their respective pressure gauges at the machine outlet.



Regulate the hydraulic system so that the outlet pressure of the unit never exceeds the working pressure of the installed product hoses.



Pressures should be nearly equal and remain constant. If the pressures oscillate at each displacement refer to the troubleshooting section before proceeding.

- l) Connect the air supply to the gun, open the manual valves of each product and perform a spray test and check the pressures on the pressure gauges of the products. If the spray test is correct and the pressures remain the same, proceed with the application.









SHUTDOWN PROCEDURES

Follow the recommended procedure, in the order given, for shutting down the machine at the end of the work:

- a) Press the  RETRACT key, it will change color .
- b) Spray with the gun into a waste container until the isocyanate dosing pump is in the reverse position and the spray fan starts to decrease.

!PRECAUTION! To avoid possible product leakage and premature deterioration of the pump packings, the pressure should not be reduced to zero. It is recommended to maintain the system with a minimum pressure of 30 bar to extend the life of the gaskets.

- c) Press the  MOTOR key, it will change color .
- d) Press the key  located next to the temperature displays of the heaters, it will change color .
- e) Press the key  located next to the HOSES/HOSES displays. It will change color .
- f) Turn the main switch to the OFF position. The upper pilot light will go out.
- g) Close the product inlet stopcocks.
- h) Shut off the supply of the transfer pumps.
- i) Disconnect the air supply to the transfer pumps.
- j) Close the manual valves of the coupling block and disassemble the gun to perform the corresponding maintenance.





CLEANING

!PRECAUTION! *The Unit includes components that reach temperatures that can cause burns. Do not handle or touch hot parts of the Unit until they have cooled down.*

To avoid possible contamination, the Unit's circuits (pumps, heaters, and hoses) should be pre-cleaned whenever applications requiring component replacement are to be performed.

Follow the recommended procedure, in the order given, for cleaning when system components need to be changed:

- a) Place two drums of DOTP cleaning agent near the machine.
- b) Make sure that the manual valves of the coupling block are closed. Disassemble the gun and leave the coupling block attached to the hoses.
- c) Remove the transfer pumps from the product drums and insert them into the DOTP cleaning agent drums.
- d) Place a container under the coupling block to collect the products contained inside the machine.
- e) Open the taps of the coupling block and press the keys  MOTOR and NORMAL to start the metering pumps.
- f) Let the products flow out until you observe that only DOTP cleaning agent completely free of impurities comes out.
- g) Close the coupling block taps and deactivate the keys  MOTOR and NORMAL.
- h) Place the transfer pumps in the drums of the new products.
- i) Place a container underneath the coupling block to collect the DOTP cleaning agent.
- j) Open the taps of the coupling block and press the keys  MOTOR and NORMAL to start the metering pumps.
- k) Allow the DOTP cleaning agent to flow out until only new products come out.
- l) When the products come out without the contamination produced by the DOTP cleaning agent, terminate the cleaning process and proceed normally.





TEMPORALY SHUTDOWN OF THE UNIT

!PRECAUTION! *The Unit includes components that reach temperatures that can cause burns. Do not handle or touch hot parts of the Unit until they have cooled down.*

When the machine is to be shut down for more than FOUR weeks, it is necessary to replace the products contained in the machine with DOTP plasticizing oil.

Follow the recommended procedure, in the order indicated, to replace the products with DOTP oil:

- a) Place two drums of DOTP cleaning agent near the machine.
- b) Make sure that the manual valves of the coupling block are closed. Disassemble the gun and leave the coupling block attached to the hoses.
- c) Remove the transfer pumps from the product drums and insert them into the DOTP cleaning agent drums.
- d) Place a container under the coupling block to collect the products contained inside the machine.
- e) Open the taps of the coupling block and press the keys  MOTOR and NORMAL to start the metering pumps.
- f) Let the products out until you observe that only DOTP cleaning agent completely free of impurities comes out.
- g) Close the manual taps of the coupling block and deactivate the keys  MOTOR and NORMAL, turn the main switch to OFF, disconnect the supply system of the transfer pumps and terminate the process. The dosing pumps, heaters and hoses must be filled with DOTP plasticizing oil. Never leave the machine or hoses empty of product or DOTP plasticizing oil.

NOTE: *Never use fluids that are not recommended or approved by Hi-Tech Spray Equipment, Inc. or recommended or approved fluids that are contaminated with water or ISO/POL. If you are unsure of the quality of the fluid you are using, we recommend that you check the machine 2-3 times every 2 weeks after filling it by recirculating through the heated hoses (see page 40) with new plasticizer, unless you are sure that the fluid coming out is completely pure and clean.*



TROUBLESHOOTING

The **G-Connect** and **G-Connect+** model unit has been designed and built to withstand severe operating conditions with a high degree of reliability, provided it is used and maintained properly. This chapter contains information on possible incidents that may cause problems that prevent further operation of the Unit. The information provided should be used as a guide to help you detect and resolve the vast majority of problems before seeking assistance from your authorized HI-TECH dealer or service center. In any case, please feel free to contact HI-TECH Spray Equipment, S.A. technical assistance service where a team of qualified technicians will assist and advise you whenever you need it.

Repairs carried out by unqualified personnel or the use of non-original spare parts may cause damage to the equipment and may result in hazardous situations for the operator.



To prevent possible personal injury caused by improper handling of the raw materials and solvents used in the process, please read carefully the safety information provided by your supplier.

Treat the originated waste according to current regulations.



Disconnect the Unit from the mains power supply before performing any operation inside the electrical console.

Electrical maintenance of the machine should only be performed by a qualified electrician.



To avoid damage caused by the impact of pressurized fluids, do not open any connections or perform maintenance work on pressurized components until the pressures have been completely eliminated.

Use appropriate protection when operating, maintaining or being present in the Unit's operating area. This includes, but is not limited to, the use of face mask, goggles, gloves, safety shoes and clothing.



The Unit includes components that reach temperatures that can cause burns. Do not handle or touch hot parts of the Unit until they have cooled down.



To prevent serious crushing or amputation injuries, do not operate the unit without the safety guards on the moving parts properly installed. Make sure that all safety guards are properly mounted when repair or maintenance work is completed.



Heaters

!WARNING! Before resolving any kind of defect, make sure all of the pushbuttons are off, that the general switch is in shutdown position and that the unit is disconnected from the power supply. Never handle the inside of the control panel with the unit connected to the power supply. The heaters are components that reach high temperatures; wait until they have cooled before handling.

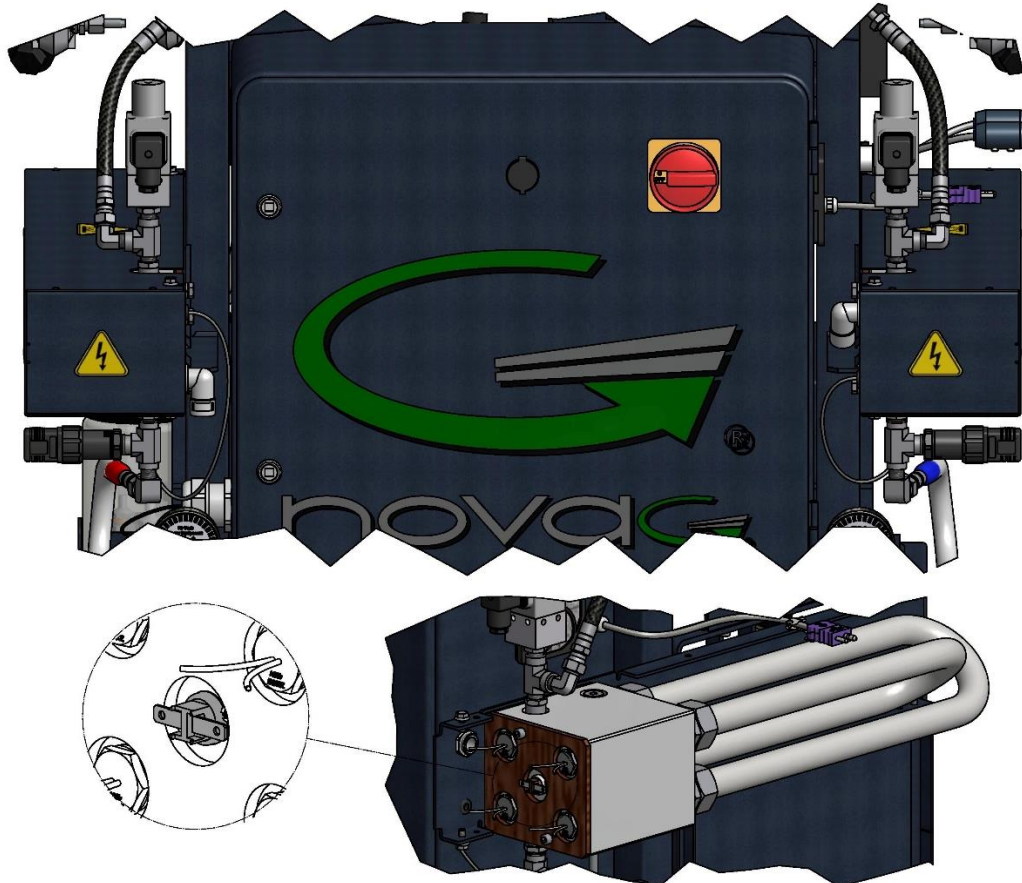

NOTE: The thermostat is a safety component that is in contact with the heater. If the temperature registered exceeds 120° C (248° F) the thermostat will cut off the power supply by deactivating K1. The thermostat will not reset until the temperature registered in the heater is below 120° C (248° F).



In case of any anomaly, follow the indications on the machine's display to solve the problem.



Service Manual

To check the state of the resistors proceed as indicated below:

With the main switch disconnected verify with a tester that the reading of the total value of the heater resistance is the one indicated in the table according to the power, voltage and number of elements installed by each heater, a higher value would indicate that one or more resistors are defective.

Disconnect them and check that the individual value of each resistor is as indicated in the table according to the power and voltage installed.

Table 2. Elements Values List

(W)	(V)	x1 (Ω)	x2 (Ω)	x4 (Ω)	x6 (Ω)
450	230	117±2	58±2	29±2	19±2
900	230	58±2	29±2	14±2	9±2
900	400	177±2	88±2	44±2	29±2
1250	230	42±2	21±2	10±2	7±2
1250	400	128±2	64±2	32±2	21±2
1250	440	154±2	77±2	38±2	25±2
1500	230	35±2	17±2	8±2	5±2
1500	400	106±2	53±2	26±2	17±2
1500	440	129±2	64±2	32±2	21±2
1800	230	29±2	14±2	7±2	4±2
1800	400	88±2	44±2	22±2	14±2
1800	440	107±2	53±2	26±2	17±2
2000	230	26±2	13±2	6±2	4±2
2000	400	80±2	40±2	20±2	13±2
2000	440	96±2	48±2	24±2	16±2



Hose Heating

¡WARNING! Before troubleshooting, make sure that all pushbuttons are turned off, the main switch is in the off position and the Unit is disconnected from the power supply. Never tamper with the inside of the control panel when the Unit is connected to the mains. The hoses can reach high temperatures, wait until they have cooled down before handling them.



In case of any anomaly, follow the indications on the machine's display to solve the problem.



Metering Pumps

!WARNING! Before troubleshooting, make sure that all pushbuttons are turned off, the main switch is in the off position and the Unit is disconnected from the power supply. Never tamper with the inside of the control panel when the Unit is connected to the mains. The dosing pumps are pressurized components, do not open any connections or carry out any repair or maintenance work on pressurized components until all pressures have been completely eliminated.

If excess pressure occurs in the isocyanate or polyol circuit, an alarm will be activated and displayed at the top of the HOME

panel .

Follow the recommended procedure, in the order given, to try to solve the problem and avoid

costly repairs. Check that all circuit breakers and control elements are in the correct working position before determining that a fault exists.

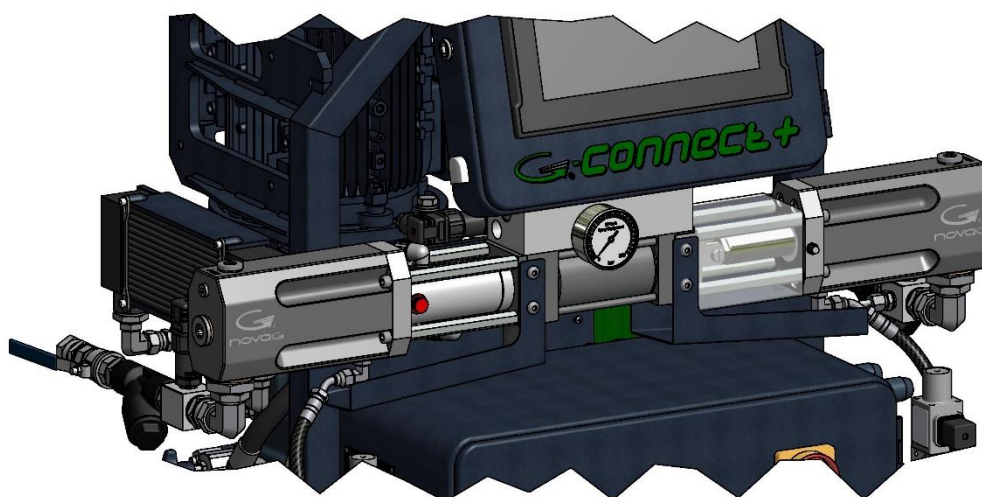

PROBLEMS

The pumps fail to maintain the pressure when the unit is shut down.

There are pressure differences between the metering pumps.

There is cavitation in the metering pump.

The metering pumps do not change direction.

The metering pumps fail to move and the direction indicator lights are out.

The movement of the metering pumps is erratic.

SOLUTIONS

1

1-2-3

1-2-3

4

4-5

4

SOLUTIONS

1. Loss in the Valve Ball

Observe the pressure gages to identify which pump fails to maintain the pressure and check the direction indicator light to determine in which direction the pump fails to maintain the pressure. If the lit lamp is the left hand one and the pressure is lost in the Polyol pump, check the discharge valve ball of the Polyol pump; or check the inlet valve ball of the Isocyanate pump, if the pressure loss is caused in the Isocyanate pump.



If the lit lamp is the right hand one and the pressure is lost from the Polyol pump, check the inlet valve ball of the Polyol pump; or check the discharge valve ball of the Isocyanate pump, if the pressure is lost from the Isocyanate pump.

Proceed as follows to check the valve balls:

- a) Disconnect the machine from the power supply and close both inlet ball valves and the supply system to the transfer pumps.
- b) Depressurize the metering pump and remove the corresponding valve ball.
- c) The loss from the valve ball is usually caused by foreign particles that prevent the perfect coupling of the ball with the ball seat. Clean the ball and the seat and make sure there are no faults from knocks, marks or scratches to the seat or the ball. If cleaning fails to resolve the problem or any fault is observed, replace the seat and the ball.

2. Pressure Imbalance

Pressures are decompensated when there is an obstruction in the hose or in the gun that prevents one of the components from leaving freely through the gun chamber when it is projected, or when a problem in the pumping system prevents one of the components reaching the gun in the required amount.

It is relatively easy to identify which component is problematic if we bear in mind that the chemical components used in the polyurethane foaming are of a different colour. By observing the color of the material that leaves the gun, we can determine which component is missing.

To determine whether the decompensation is caused as a result of an obstruction or as a consequence of a problem in the pumping system, project with the gun, observe the pressure indicated on the corresponding pressure gage to the missing component and compare it with the pressure indicated by the gage to the other component: if the pressure of the missing component is higher, the decompensation is the result of an obstruction, if the pressure is lower, the decompensation is the consequence of a problem in the pumping system.

3. Cavitation

Cavitation occurs when the metering pump requires a larger volume of material than that supplied by the feeding system, causing the formation of a vacuum in the inlet of the metering pump. The causes of cavitation are the following:

- a) The transfer pump fails to supply the necessary volume. The problem might be in the pump not meeting the required specifications, in the lack of air supply to the pump or that the pump is faulty. A pump is recommended with a ratio of 2:1 for transferring the Isocyanate and a supply hose with an interior diameter of at least 20 mm ($\frac{3}{4}$ in).
- b) High viscosity. The polyurethane foaming systems normally require a minimum transfer temperature of 12° C (55 F); at lower temperatures, the product increases its viscosity, making the pumping more difficult. When the ambient conditions prevent the products from being maintained at a minimum temperature of 12° C (55 F) auxiliary heating elements must be used to condition the products as the minimum temperature required for the transfer.
- c) The product inlet filter is obstructed (see Maintenance).
- d) The inlet valve ball has leaks as a result of wear or possible faults in the ball or the closing surface of the seat, which means that part of the material supplied returns to the supply tank and that the metering pump supplies a smaller volume of material in the discharge cycle, causing an incorrect ratio.



4. Fault in the Reversing Switch

The metering pump system has a plate that activates the reversing switches to carry out the change of direction. The most common cause of the fault is the deformation of the plate or the entry of a foreign body preventing the plate from making contact with the micros.

Failure to move the directional valve will cause the activation plate to overrun the micro and not perform the directional change.



Faced with any anomaly follow the instructions indicated on the screen to solve any problem.

5. Over Pressure Safety Switch

Each metering pump is protected by a safety pressure switch factory set to limit the pressure depending on the size of the pumps installed in the unit. For **1.2** and **0.8** size pumps, the limit pressure set in the factory is 270 bar (3900 psi). When the limit pressure is reached, the pressure switch interrupts the electrical supply to the directional valve, stopping the pumps. When the pumps stop, the direction indicator lights will go out and an alarm will be activated.



Faced with any anomaly follow the instructions indicated on the screen to solve any problem.

When the pressure reaches lower values than the established limit, the metering pumps will restart. However, the causes of the excess pressure must be determined and corrected.



Hydraulic Unit

!WARNING! Before resolving any kind of defect, make sure all of the pushbuttons are off, that the general switch is in shutdown position and that the unit is disconnected from the power supply. Never handle the inside of the control panel with the unit connected to the power supply. The hydraulic unit is a component that works under pressure; do not open any connection or carry out maintenance work on components subject to pressure until all of the pressures have been completely eliminated.

Follow the recommended procedure in the order indicated, to try to solve the problem and avoid costly repairs. Make sure all the automatic switches and control elements are in the correct working position before determining the existence of a fault.

PROBLEMS

- The electric motor does not start or stops while it is working.
- The hydraulic pump fails to develop pressure.
- Little or no pressure with screeching.

SOLUTIONS

- 1
- 2
- 2-3

SOLUTIONS

1. Automatic Switch

The electric motor is protected by an overload safety switch that triggers when the motor draws excessive current. Disconnect the machine from the power supply, allow the motor to cool, open the control panel and reset the automatic switch for the motor.



Faced with any anomaly follow the instructions indicated on the screen to solve any problem.

It is important to determine the reason why the motor has been subject to an overload. Reset one time only or the electric motor may be damaged due to overheating.

2. Little or No Pressure

The most likely causes of low or no pressure is usually a deficient supply of the hydraulic fluid to the pump. This can be caused by incorrect priming, a lack of hydraulic fluid or dirt in the return filter. Check the indicated points to guarantee correct operation.

3. Noise

A noise similar to screeching is a symptom of cavitation. The noise is normal if it occurs when starting and lasts for approximately thirty seconds.

If the noise continues, stop the machine to protect the hydraulic pump and make sure that the connectors are tight and that the pump has been correctly primed.

Another possible cause of noises in the pump is excessive temperature in the hydraulic oil. Make sure the oil supply is correct, and, if necessary, improve the ventilation to allow better dissipation of the heat in the hydraulic tank.



MAINTENANCE

To achieve maximum output from the **G-Connect** and **G-Connect+** unit, certain daily or regular maintenance operations are needed.



To prevent possible bodily harm caused by incorrect handling of the raw materials and solvents used in the process, carefully read the safety information provided by your supplier.

Deal with the waste created according to current regulations.



Disconnect the unit from the power supply before carrying out any operation inside the electrical console.

The electrical maintenance of the machine must only be performed by a qualified electrician.



To avoid damage caused by the impact of pressurized fluids, do not open any connection or perform maintenance work on components subject to pressure until the pressures have been completely eliminated.



Use suitable protection when operating, maintaining or remaining in the operating area of the unit. This includes, but is not limited to, the use of face masks, protective goggles, gloves, shoes and safety clothing.

The unit includes components that reach temperature that are liable to cause burns. The hot parts of the unit must not be handled until they have cooled.



To prevent serious harm by crushing or loss of limbs, do not work with the unit without the safety duly installed on all moving parts. Make sure that all of the safety protections are correctly fitted after all repair or maintenance work.



Heaters

!WARNING! Before performing any maintenance work, make sure all of the pushbuttons are off, that the general switch is in shutdown position and that the unit is disconnected from the power supply source. Never handle the inside of the control panel with the unit connected to the power supply. The heater is a component that reaches high temperatures; wait until it has cooled before handling.

1. Heating Elements

To replace a faulty element, proceed as follows:

- a) Depressurize the unit, disconnect it from the power supply and remove the cover on the heater.
- b) Disconnect the element from the terminal block and with an appropriate spanner, loosen the element and remove it from its housing. Inspect the element; it must be smooth and shiny in appearance. If it is blackened or has material adhered, replace it.
- c) Check the new element with a tester: the reading of the value of the resistance must be as shown in **Table 2** on **pag.46**.
- d) Apply Teflon or sealing paste to the thread and assemble the element into its housing.
- e) Reconnect the wires to the terminal block; make sure the connection is in parallel and fit the heater cover.
- f) Before operating the unit, replace the protective casing around the heater.

NOTE: If the element that must be replaced is the one in contact with the temperature probe, first remove the probe.

2. Temperature

The temperature probe is fixed to the connector with a ferule and a torque nut. Once inserted in its housing, the ferule forms to the probe and does not allow it to be relocated or moved. The location of the probe is very important and must be done correctly before fitting the torque nut.

- a) Depressurise Depressurize the unit and disconnect it from the power supply. Check the torque of the body of the connector inserted in the heater to prevent leaks.
- b) Assemble the heating element.
- c) Insert the torque nut and the ferule in the probe and insert this in the connector body until it comes into positive physical contact with the heating element. Make sure the spring does not prevent the probe from making contact with the resistance
- d) Fix the probe in place and tighten the torque nut.



Hydraulic Unit

!WARNING! Before performing any maintenance work, make sure all of the pushbuttons are off, that the general switch is in shutdown position and that the unit is disconnected from the power supply. Never handle the inside of the control panel with the unit connected to the power supply. The hydraulic unit is a component that works under pressure; do not open any connection or carry out maintenance work on components subject to pressure until all of the pressures have been completely eliminated.

The hydraulic unit must be serviced each year as indicated below:

- a) Depressurize the unit and disconnect it from the power supply. Clean the hydraulic tank lid to prevent foreign bodies from falling into the tank when the lid is removed.
- b) Separate the lid and the motor-pump assembly from the hydraulic tank. Inspect the bottom of the tank for sediments. If there is sediment present, the tank must be emptied completely and the bottom must be cleaned, eliminating all the sediment and filling it once more with new hydraulic fluid.
- c) Clean the suction pipe and its connections.
- d) Replace the oil filter of the return line.
- e) Check that the hydraulic pump is full of fluid and check all hydraulic connections.
- f) Mount the lid and the motor-pump assembly.
- g) Proceed with the normal operation.



Metering pumps

!WARNING! *Before resolving any kind of defect, make sure all of the pushbuttons are off, that the general switch is in shutdown position and that the unit is disconnected from the power supply source. Never handle the inside of the control panel with the unit connected to the power supply. The metering pumps are components that work under pressure; do not open any connection or perform repair or maintenance work on components subject to pressure until all pressures have been completely released.*

When the pump is operating properly, it is not uncommon for a small amount of resin to seep past the seals and onto the visible part of the pump shaft. Periodically inspect the shaft and clean out debris when the metering pumps are stopped and the machine is turned off.

Dismantle and clean the metering pumps annually, even if there are no apparent signs of leakage. Take advantage of this circumstance to replace all the gaskets and bushings, since if you reassemble any element that apparently is not damaged, this can cause premature wear of the rest of the components (in the Component Manual NR-00023 of Novag, the gasket kits corresponding to each model and size of pump are available). The distributor bases of the pumps should also be inspected, checking that the ball valves do not show signs of wear, knocks or marks that affect the correct operation of the pump.

Inspect the lubrication reservoir of the Isocyanate pump daily and check the condition of the plasticizing DOTP oil it contains. Replace the oil when you observe changes in color or when it shows signs of solidification. If this persists, replace the seals of the isocyanate pump using the corresponding kit.

In cases where the machine is subjected to heavy workloads or special working conditions, disassemble, clean and replace the seals of the metering pumps every six months.

Inspect rods, plungers and inside of liners for marks or scratches that may cause leakage and premature damage to seals.

Only qualified personnel are authorized to replace the seals on metering pumps, as they have the knowledge and tools required for this purpose. These tools can be purchased upon request.

NOTE: *Three special tools can be used to simplify the seal assembly. Tools A and B to insert the shaft seal into the seal housing and tool C for the packing retainer flange assembly insertion through the shaft (see Table 3 in pag.56).*



Table 3. Tools for shaft seal assembly

	Tool (A)	Tool (B)	Tool (C)
Pump #0.80	HT-00124	HT-00125	HT-00036
Pump #1.20			HT-00035

Seals assembly

PISTON SEAL		
<p>Insert the piston bearing, seal and washer into the piston shaft. Face the lips of the seal towards the end of the shaft. Face the grooves of the washer towards the seal.</p>	<p>Thread the plunger assembly onto the shaft as far as it will go (the pin holes in the shaft and plunger should line up).</p>	<p>Insert the spring pin so that it is recessed in the groove of the shaft. Insert the snap ring into the groove.</p>



SHAFT SEAL		
<p>Insert the Retainer (1) into Tool A (2). Make sure that the lips are facing upwards.</p>	<p>Place tool A with the seal (3) inside the seal housing (4). With tool B (5) push the seal until it stops against the seal housing (4).</p>	<p>Place the shaft bearing (6) and the seal housing along with its corresponding O-rings (7) on the packing retainer flange (8).</p>
<p>Insert the shaft assembly (10) into the pump body (9) and place the tool C (11) on the tip of the shaft.</p>	<p>Mount the packing retainer flange assembly with all components assembled (12) on the front face of the pump. The shaft bearing should be visible from the outside.</p>	<p>Remove tool C and fix the packing retainer flange with its corresponding screws.</p>

Corresponding instructions are supplied with the specific tools.



Inlet supply filter

The filter bodies have a filter screen that prevents solid particles from entering the unit. Inspect the filters each day as part of the machine start-up, and clean them. Replace the filter screen if necessary.

Isocyanate is a product that crystallizes with ambient moisture or freezing. If the storage and transfer is correct and the operating procedures are respected, the risk of contamination of the Isocyanate filter will be minimized.

NOTE: Clean the Isocyanate inlet filter before the daily start-up; it should not be cleaned after the machine has been stopped for the day. Immediate use after cleaning the filter reduces the risk of moisture contamination or contamination through the reaction with the solvent used in the cleaning operation

To check the product inlet filters, proceed as follows:

- a) Disconnect the unit from the power supply and close the inlet ball valve from the filter you wish to check.
- b) Place a suitable vessel under the filter to collect the product coming out on removal. Carefully loosen the filter stopper to allow the product to be emptied into the vessel below. Completely unscrew the stopper.
- c) Remove the seal, the spring and the mesh and clean it all with the solvent used for cleaning the gun. Dry it all and check that the mesh is not obstructed. The holes in the mesh must be completely free. Replace the mesh if more than 10% of the surface is obstructed.
- d) Refit the mesh, the spring and the seal. Screw on the stopper.
- e) Open the product entry valve of the filter, make sure there are no leaks and proceed with the normal operation.



Isocyanate pump lubrication system

Each day, inspect the lube reservoir of the Isocyanate pump and check the condition of the DOTP. Replace the oil when it shows changes in colour or signs of solidification.

Oil solidification is the result of the absorption of moisture and the maintenance interval will depend on the working conditions. The closed circuit system reduces contamination.

Oil discoloration is due to the small film of Isocyanate that lies on the pump shaft during the pumping operation. If the gaskets and the seals are in a good condition, the plasticizer will not have to be changed so frequently.

To replace the plasticizer, proceed as follows:

- Project the gun until the Isocyanate metering pump is placed on the right hand side. Press the NORMAL key to interrupt the working cycle. The pushbutton led will go out.
- Press the MOTOR and POWER CONTROL keys and turn the general switch OFF. Disconnect the machine from the power supply.
- Remove the tank from the support, unscrew the lid, remove the non-return valve of the suction hose, empty the contaminated plasticizer in a suitable vessel and refit the non-return valve in the suction hose.



Pay attention to the mounting position of the backflow preventer, there is a mark indicating the flow direction, so if you disassemble the suction backflow preventer you must reassemble it with the arrow pointing upwards. For easy identification, the suction circuit is with tube Ø12 mm (backflow preventer upwards) and the return circuit is with tube Ø10 mm (backflow preventer downwards).

- Clean the tank, fill it with DOTP, screw on the lid and refit the tank in the support. The system is auto-suction and does not need priming.

SUCTION LINE

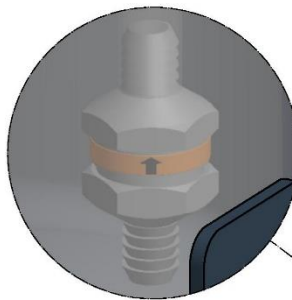

RETURN LINE

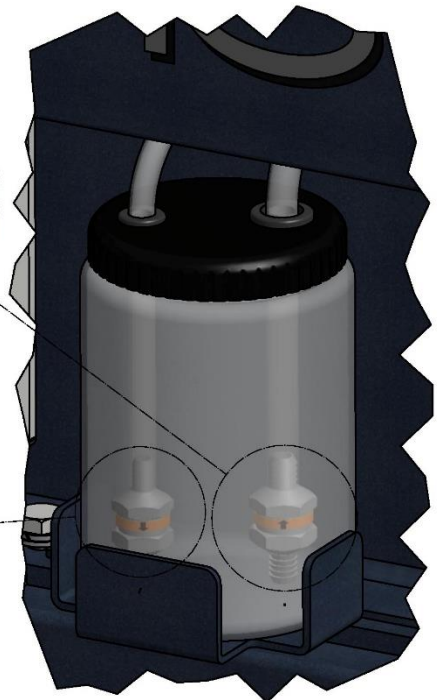



CONTENT

Warranty	2
Safety and Handling	3
Characteristics	6
Principal Heating System	6
Hose Heating System	6
Double Acting Opposed Piston Metering Pumps	6
Technical Specifications “G-Connect”	7
Electrical	7
Mechanical	7
Acoustic	7
Technical Specifications “G-Connect+”	8
Electrical	8
Mechanical	8
Acoustic	8
General Description	9
Touch Screen	12
Description of the Screens	12
Description of the Machine Product Control Areas	13
Description of the Hose Product Control Area	14
Description of the Control Unit Area (Manual mode)	15
Area Description Control Unit (Automatic mode)	16
Main Bar Description	17
Main Menu	18
HOME	18
PARAMETERS	19
DOSAGE	21
DRUMS	24
SYSTEMS	25
GRAPHICS	26
COMMUNICATION	27
ALARMS	29
Method of Threaded Union of the Hoses	30
Installation	31
StartUp Method (Manual)	39
Shutdown procedures	41
Cleaning	42
Temporaly Shutdown of the Unit	43
Troubleshooting	44
Heaters	45



Hose Heating _____	47
Metering Pumps _____	48
Hydraulic Unit _____	51
Maintenance _____	52
Heaters _____	53
Hydraulic Unit _____	54
Metering pumps _____	55
Seals assembly _____	56
Inlet supply filter _____	58
Isocyanate pump lubrication system _____	59
Content _____	60
List of Illustrations _____	62
List of Tables _____	62



LIST OF ILLUSTRATIONS

Figure 1. General Description.	9
Figure 2. Screen “HOME”.	12
Figure 3. Method of threaded Union for Hoses	33

LIST OF TABLES

Table 1. Tightening Threaded Joints	30
Table 2. Elements Values List	46
Table 3. Tools for shaft seal assembly	56