

Service Manual

Dosing Unit

BITUMEN-2K

Issue 1.2 19/09/22
Ref. NR-00014-ENG

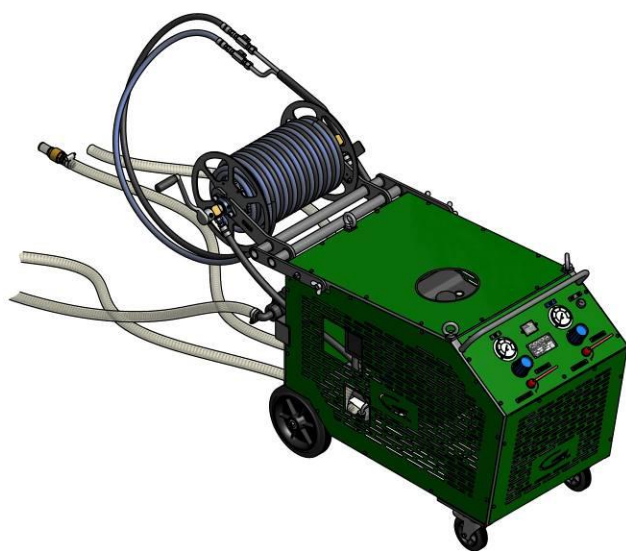

Before installing and starting the Unit, carefully read all of the technical and safety documentation included in this Service Manual. It is very important that you pay attention to the information in the manual to understand the handling and conditions for using the Unit. All of the information is aimed at improving the safety of the users and avoiding possible malfunctions due to incorrect use of the dosing Unit.



GUARANTEE

HI-TECH SPRAY EQUIPMENT, S. A. (hereinafter “**HI-TECH**”) grants this limited Guarantee to the original purchaser (hereinafter, the “Client”) for the original equipment and accessories delivered with the equipment (hereinafter, the “Product”) against all design, material, and manufacturing defects of the Product at the time of the initial purchase by the user and for a period of two (2) years from that date.

If, during the guarantee period and under normal conditions of use, the Product ceases to function correctly for causes that can be attributed to defects in the design, materials, or manufacturing, the authorized distributor in the country in which the Product was purchased, or **HI-TECH's** technical assistance service, will repair or replace the Product in accordance with the following:

CONDITIONS

- a) The validity of this guarantee shall be contingent upon the submission, along with the Product delivered for repair or replacement, of the original invoice issued by the distributor authorized by **HI-TECH** for the sale of the Product, which must specify the date of purchase and the serial number. **HI-TECH** reserves the right to refuse to provide guarantee service when the aforementioned information is not included in the invoice or has been modified after the purchase of the Product.
- b) The Product that is repaired or replaced will maintain the original guarantee for the remaining time until the guarantee ends or for three (3) months from the date of repair, if the remaining original guarantee period is less than that.
- c) This guarantee shall not apply to Product malfunctions caused by deficient installation of the Product, due to natural wear and tear of the components, any use other than that which is deemed normal for this Product or that fails to comply strictly with the operating instructions provided by **HI-TECH**; due to accidents, carelessness, adjustments, alterations, or modifications of the Product not authorized by **HI-TECH** or due to the use of accessories, heating devices, pump units and/or dispensers that are not manufactured or approved by **HI-TECH**.
- d) The guarantee that applies to the components and accessories that form part of the Product and that were not manufactured by **HI-TECH** shall be limited to the guarantee offered by the original manufacturer of the components or accessories in question.

HI-TECH WILL NOT RECOGNIZE OTHER EXPRESS ORAL OR WRITTEN GUARANTEES OTHER THAN THIS PRINTED LIMITED GUARANTEE. ALL IMPLICIT GUARANTEES, INCLUDING, BUT NOT LIMITED TO THE SUITABILITY FOR A SPECIFIC USE, ARE DEPENDENT ON THE DURATION OF THIS WRITTEN GUARANTEE. HI-TECH ASSUMES NO COMMITMENT OR LIABILITY FOR POSSIBLE HARM OR EXPENSES RESULTING FROM MALFUNCTIONS IN THE PERFORMANCE OF THE PROJECT, ITS OPERATION, OR THE DISPENSING OF MATERIAL THROUGH THE PRODUCT, INCLUDING, BUT NOT LIMITED TO EXPENSES GENERATED AS A RESULT OF DAMAGES TO PERSONS OR THE OWNER. LIKEWISE, HI-TECH SHALL NOT BE LIABLE UNDER ANY CIRCUMSTANCES FOR THE LOSS OF FUTURE PROFITS OR LOST SALES. THE REPAIR OR REPLACEMENT OF THE DEFECTIVE PRODUCT SHALL CONSTITUTE COMPLETE COMPLIANCE BY HI-TECH IN REGARD TO THE CLIENT. HI-TECH DOES NOT IN ANY WAY GUARANTEE THE SUITABILITY OF ITS PRODUCT FOR ANY SPECIFIC PURPOSE OR APPLICATION.

All of the information provided that corresponds to the components not manufactured by **HI-TECH** and that is based on reports received from the original manufacturer, even if considered accurate and reliable, is provided without any express or implicit guarantee or liability of any type.

The transfer, sale, or leasing of the Product by **HI-TECH**, under no circumstances expressly or implicitly constitutes an authorization, consent, or granting of the use of any rights or patents, or promotes, encourages, or supports their infringement.

The guarantee restrictions do not limit the consumer's legal rights as stipulated in the applicable national legislation, nor do they affect the rights deriving from the purchase and sale contract between the consumer and the supplier.



Service Manual

All of the information provided in this manual has been included with the confidence that it is true, but this does not constitute any implicit or explicit guarantee. **HI-TECH** reserves the right to make, at any time and without prior notice, the necessary improvements and modifications to this manual in order to rectify possible typographical errors, expand the information provided, and introduce the changes in the characteristics and functions of the equipment.

SAFETY AND HANDLING

The equipment described in this manual has been designed and manufactured in compliance with the following European Directives, following as application guide the harmonized standards detailed and in conformity with the relevant UK Statutory Instruments (and their amendments):

Directive 2006/42/EC on machinery (UK Supply of Machinery (Safety) Regulations 2008)

UNE EN 12100:2012 (BS EN ISO 12100:2010)

Directive 2014/30/EU on electromagnetic compatibility (UK Electromagnetic Compatibility Regulations 2016)

UNE EN 55011 (BS UNE EN 55011)

UNE EN 55016-2-1 (BS UNE EN 55016-2-1); UNE EN 55016-2-3 (BS UNE EN 55016-2-3);
UNE EN 55032 (BS UNE EN 55032)

UNE EN 61000-3-2 (BS UNE EN 61000-3-2); UNE EN 61000-3-3 (BS UNE EN 61000-3-3);
UNE EN 61000-4-2 (BS UNE EN 61000-4-2); UNE EN 61000-4-3 (BS UNE EN 61000-4-3);
UNE EN 61000-4-4 (BS UNE EN 61000-4-4); UNE EN 61000-4-5 (BS UNE EN 61000-4-5);
UNE EN 6100-4-6 (BS UNE EN 6100-4-6); UNE EN 61000-4-8 (BS UNE EN 61000-4-8); UNE
EN 61000-4-11 (BS UNE EN 61000-4-11)

Directive 2014/68/EU on pressure equipment (UK Pressure Equipment (Safety) Regulations 2016)

UNE EN 809:1999 +A1 (BS EN 809:1998 +A1:2009)

Directive 2014/35/EU on electrical safety (UK Electrical Equipment (Safety) Regulations 2016)

UNE EN 60204-1:2019 (BS EN 60204-1:2018)

Directive 2003/10/EC on noise level (UK The Control of Noise at Work Regulations 2005)

UNE EN ISO 3740 (BS EN ISO 3740:2019)

UNE EN ISO 3746 (BS EN ISO 3746:2010)

Directive 2011/65/EU and the correction in its Annex II according to Directive 2015/863/EU on the restriction of the use of certain hazardous substances in electrical and electronic equipment

Directive 2012/19/EU on waste electrical and electronic equipment

Regulation (EU) 2016/1628 on engine emissions, Phase V



Dosing Unit BITUMEN-2K

Service Manual



Electrical products cannot be thrown out with the rubbish. They must be taken to a dedicated collection point for an environmentally sound disposal in accordance with local regulations. You must contact your local collective or retailer for information about recycling. Before leaving WEEE at appropriate collection facilities, batteries must be removed and disposed of separately for proper recycling. The packaging materials are recyclable. Dispose of packaging materials in an environmentally sound manner and place them at the disposal of recycling

sectors.

TRANSPORT AND STORAGE

Proper precautions must be taken so that the equipment can withstand the effects of transport and storage temperatures between -25°C and $+55^{\circ}\text{C}$ or up to $+70^{\circ}\text{C}$ for short periods that do not exceed 24 hours. Also, appropriate means to prevent damage from moisture, vibrations or shocks must be foreseen.

This chapter contains important information on the safety, handling, and use of the **BITUMEN-2K** dosing unit.



Before installing and starting the Unit, carefully read all of the technical and safety documentation included in this Service Manual. It is very important that you pay attention to the information in the manual to understand the handling and conditions for using the Unit. All of the information is aimed at improving the safety of the users and avoiding possible malfunctions due to incorrect use of the dosing Unit.

WARNING! indicates information to alert you to situations that could cause serious injury if the instructions are not followed.

CAUTION! indicates information that is provided to avoid possible damage to the Unit and/or to indicate how to avoid situations that could cause minor injuries.

Dosing Unit BITUMEN-2K



Service Manual

A **NOTE** is relevant information on the procedure that is being described.

A careful reading of this manual will give you a better understanding of the unit and the procedures. By following the instructions and recommendations contained in this manual, you will reduce the potential risk of accidents during the installation, use, or maintenance of the Unit, and you will obtain better performance, functioning without incidents for a longer time, and the possibility of detecting and solving problems quickly and easily.

Keep this Service Manual for future consultation and useful information at any time. If the manual is lost, request a new copy from your local **HI-TECH** distributor or contact **HI-TECH SPRAY EQUIPMENT, S.A.** directly

WARNING! *The BITUMEN-2K dosing unit was not designed for use in potentially explosive atmospheres or to exceed the pressure limits described in the technical specifications of this manual.*

When operating the Unit, the use of proper clothing and personal protection elements is essential, including, but not limited to, gloves, safety glasses, safety footwear, and face mask. The implementation and following of safety measures should not be limited to the ones described in this manual. Before putting the Unit into operation, a detailed analysis must be done of the risks generated by the products to be dispensed, the type of application, and the work environment.



To prevent possible bodily injury caused by the incorrect handling of the raw materials and products used in the process, read the safety information provided by your supplier carefully.



To avoid injury caused by the impact of pressurized fluids, do not open any connections or carry out any maintenance work on components subjected to pressure until the pressure has been completely released.



Use proper protection when operating, carrying out maintenance tasks, or standing in the operating area of the Unit. This includes but is not limited to the use of face masks, safety glasses, gloves, safety footwear and clothing.

The Unit's engine may reach temperatures that could cause burns. Don't handle or touch hot parts of the engine until they have cooled.

Read all of the technical and safety documentation included in this Service Manual carefully.



To prevent serious injury caused by impact or amputation, do not work with the Unit without the safety guards of the moving parts properly installed. Make sure that all safety guards are correctly installed when repair or maintenance has been finished.



CHARACTERISTICS

The **BITUMEN-2K** dosing unit was designed and built for the application of the **BITUMEN-2K** two-component system.

Emulsion Delivery System

Made up of an external gear pump with 30 cc cylinder, driven by a gasoline engine.

Provides a constant flow and guarantees uniform spray pressure.

The rotation ratio with the engine is 1.5:1.

Catalyst Delivery System

Made up of a roller pump with 15 cc cylinder, driven by a gasoline engine.

Provides a constant flow and guarantees uniform spray pressure.

The rotation ratio with the engine is 2.4:1.

Recirculation System

Homogenizes the two products before initiating spraying. The system is equipped with a manual activation valve for each product that allows the recirculation and spray circuits to be closed or open. In recirculation mode, the products delivered by the pumps return to the feed tanks.

Gasoline Engine

It is equipped with a 12 V electric start and generates a maximum power of 9 hp.

It runs on 95 octane unleaded gasoline.

To use another type of gasoline, read the engine's service manual.



Before starting the engine, carefully read all of the technical and safety documentation included in the engine service manual and delivered along with each spray unit. It is very important that you pay attention to the information in the manual to understand the handling and conditions for using the engine. All of the information is aimed at improving the safety of the users and avoiding possible malfunctions due to incorrect use of the engine.



TECHNICAL SPECIFICATIONS

Maximum catalyst spray pressure _____ 10 kgf/cm² (0.98 MPa) / 142 psi
Maximum catalyst flow (engine @ 3400 r.p.m.) _____ 22 l/min / 5.8 gal/min
Maximum emulsion spray pressure _____ 20 kgf/cm² (1.96 MPa) / 284 psi
Maximum emulsion flow (engine @ 3400 r.p.m.) _____ 68 l/min / 18 gal/min
Maximum flow with NF03 nozzle @ 10 kgf/cm² (catalyst) _____ 2.2 l/min / 0.58 gal/min
Maximum flow with NF30 nozzle @ 20 kgf/cm² (emulsion) _____ 29 l/min / 7.7 gal/min
Length of spray hoses _____ 35 m
Length of the intake and return hoses _____ 5 - 6 m

A-weighted sound pressure level: _____ --,- dB (A)

A-weighted sound power level: _____ --, - dB (A)

Values obtained according to UNE-EN ISO 3746:1995 standard.

Approximate weight with hoses _____ 200 kg

Approximate weight without hoses _____ 160 kg

Dimensions _____ H: 100 cm / W: 60 cm / L: 150 cm



GENERAL DESCRIPTION OF PRINCIPAL COMPONENTS

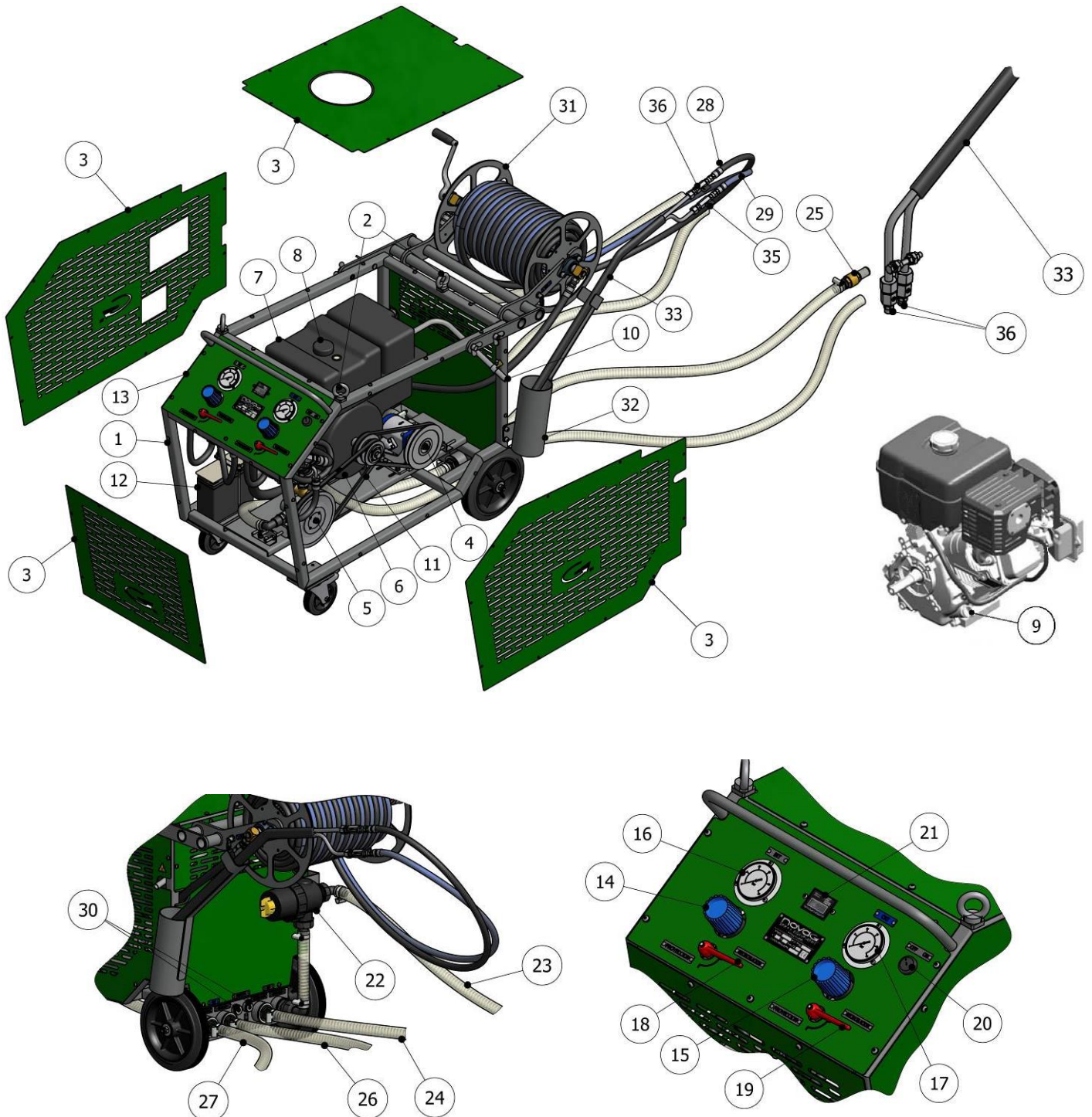

Figure 1. *General Description*

Dosing Unit BITUMEN-2K



Service Manual

1. Chassis
2. Loading Rings for Transport
3. Safety Guards
4. Emulsion Dosing Pump
5. Catalyst Dosing Pump
6. Engine
7. Gasoline Tank
8. Gasoline Fill Cap
9. Oil Fill Cap
10. Exhaust Pipe
11. Engine Transmission
12. Battery
13. Control Panel
14. Emulsion Pressure Regulator
15. Catalyst Pressure Regulator
16. Emulsion Hydraulic Pressure Gauge
17. Catalyst Hydraulic Pressure Gauge
18. Emulsion Recirculation Valve
19. Catalyst Recirculation Valve
20. Engine Ignition Switch
21. Tachometer and Hour Counter
22. Emulsion Intake Filter
23. Emulsion Intake Hose
24. Emulsion Return Hose
25. Catalyst Intake Filter
26. Catalyst Intake Hose
27. Catalyst Return Hose
28. Emulsion Spray Hose
29. Catalyst Spray Hose
30. Auxiliary Connections for Dual Spraying
31. Hose Reel
32. Lance Storage
33. Spray Lance
34. Emulsion Valve
35. Catalyst Valve
36. Spray Nozzle



STARTUP PROCEDURE

- a) Fill the fuel tank, approximately 6 litres. The gasoline must comply with the characteristics and specifications in the engine service manual (read the engine service manual).

NOTE: Do not fill the tank to its maximum capacity (6 l). Always fill to 2-3 cm below the top of the neck to allow for expansion of the fuel. If you spill any fuel during filling, clean the area around the tank.

WARNING! Never refuel while the engine is running or in closed spaces that could result in inhalation of toxic gases.

- b) Fill the oil tank, approximately 1 litre. The oil must comply with the characteristics and specifications in the engine service manual (read the engine service manual).

NOTE: Change the oil after the first 5 hours of engine operation. (Read the engine service manual).

WARNING! Do not add oil while the engine is running.

- c) Connect the emulsion intake hose to the connection on the machine and tighten the flange (length 5 m).
- d) Connect the catalyst intake hose to the connection on the machine and tighten the flange (length 5 m).
- e) Connect the emulsion return hose to the connection on the machine and tighten the flange (length 6 m).
- f) Connect the catalyst return hose to the connection on the machine and tighten the flange (length 6 m).
- g) Connect the emulsion intake hose to its container.
- h) Insert the emulsion return hose into the opening on the top of the emulsion container. Make sure that it will not slide out.
- i) Insert the catalyst intake and return hoses into their containers. Make sure that they will not slide out.

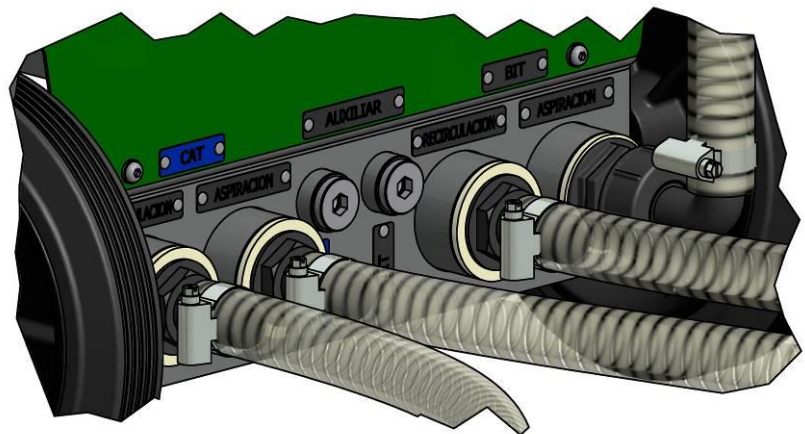

NOTE: The product hoses are identified by red tape (catalyst) and black tape (emulsion), making it easy to quickly distinguish between them.

Make sure that the hoses are connected correctly to prevent possible product leaks and to prevent mixing up the circuits.

Dosing Unit BITUMEN-2K



Service Manual

- j) Make sure that the valve on the emulsion filter is open.
- k) Make sure that the product output valves on the spray lance are closed.
- l) Make sure that the slots of the spray nozzles are oriented in the desired position. If not, turn to adjust them.
- m) Make sure that the slots of the spray nozzles are clean. Clean if necessary.
- n) Make sure that the valves on the control panel are in the recirculation position. If not, turn to adjust them.
- o) Start the engine (see the specific sequence in the "STARTUP" section of the engine manual).
- p) Set the revolutions per minute of the engine to approximately 3200, moving the acceleration control lever.

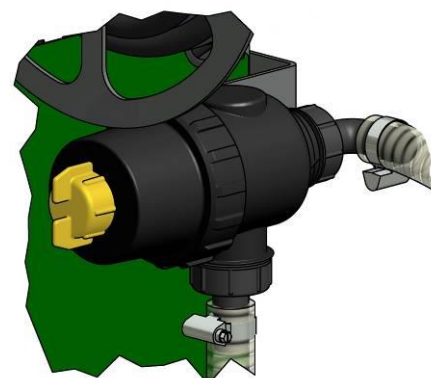

NOTE: To do this, follow the procedure described in the engine service manual.



Before starting the engine, make sure that all of the safety guards are in place and carefully read all of the technical and safety documentation included in the engine service manual and delivered along with each spray unit. It is very important that you pay attention to the information in the manual to understand the handling and conditions for using the engine. All of the information is aimed at improving the safety of the users and avoiding possible malfunctions due to incorrect use of the engine.

Never work with the engine running in an enclosed space; inhaling the exhaust gases could cause serious injury or even death.

- q) Allow the two products to recirculate for approximately 10 minutes until they have mixed uniformly.

NOTE: Before stopping the recirculation, make sure that there are no air bubbles in the hoses; if you see any bubbles, continue recirculating until they disappear.

- r) Turn the valves on the control panel to the spray position.
- s) Adjust the emulsion pressure
- t) Adjust the catalyst pressure

WARNING! Never exceed 10 Bar of pressure in the catalyst pump.

- u) Open the manual valves on the lance and test the spray in a small area. During the spray test, verify that the selected pressure values remain stable.

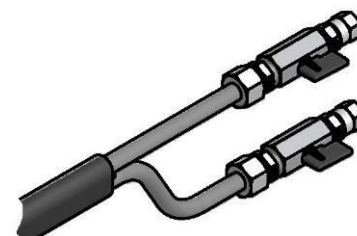



WARNING! Do not aim the nozzles at the face or any other part of the body of the operator or of other people.

- v) Close the manual valves on the lance when you are done spraying.

SHUTDOWN METHOD

CAUTION! Some of the Unit's components may reach temperatures that could cause burns. Don't handle or touch hot parts of the Unit until they have cooled.

Follow the recommended procedure, in the specified order, to shut down the unit after completing the spraying operation:

- a) Close the manual valves on the lance.
- b) Turn off the engine (see the specific sequence in the "SHUTDOWN" section of the engine manual).
- c) Close the manual valve on the emulsion filter.
- d) Disconnect the intake hose from the emulsion container and insert it into a waste container until its contents have drained out.
- e) Pull the hose out of the container and set it on the floor.
- f) Remove the intake hose from the catalyst container and insert it into a waste container until its contents have drained out.
- g) Pull the hose out of the container and set it on the floor.
- h) Start the engine.
- i) Make sure that the manual valves on the control panel are in spray mode.
- j) Insert the lance into the waste container.
- k) Open the manual valves on the lance and empty the contents of the hoses into the container.
- l) When the product stops coming out, close the valves on the lance.
- m) Turn off the engine immediately.

WARNING! To guarantee perfect functioning, minimize the time that the pumps are running while empty.

- n) Fill the bottom of the lance storage container with solvent (approximately 2 cm).
- o) Insert the lance into the container.

To empty the waste from the inside of the lance storage, remove the drain plug at the bottom.

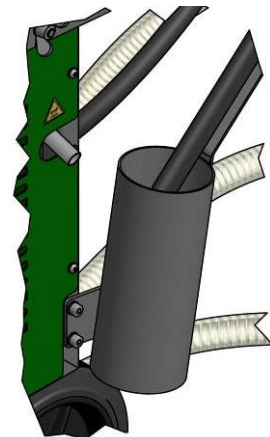

CLEANING PROCEDURE

Follow the recommended procedure, in the specified order, to clean the unit:

- a) Put a container with DIESEL FUEL close to the machine to clean the emulsion.
- b) Put a container with CLEAN WATER close to the machine to clean the catalyst.
- c) Insert the emulsion intake hose into the diesel container.
- d) Insert the emulsion recirculation hose into the waste container.
- e) Insert the catalyst intake hose into the container with the water.
- f) Insert the catalyst recirculation hose into the waste container.
- g) Make sure that the valves on the control panel are in recirculation mode. If not, turn them to the correct position.
- h) Make sure that the manual valves of the lance are closed.
- i) Start the engine.
- j) Lower the revolutions per minute to approximately 1500.
- k) Recirculate for approximately a ½ minute and turn the valves on the control panel to the spray position.
- l) Wait another ½ minute and shut off the engine.
- m) Check the condition of the emulsion intake filter. Clean with clean diesel fuel if necessary.

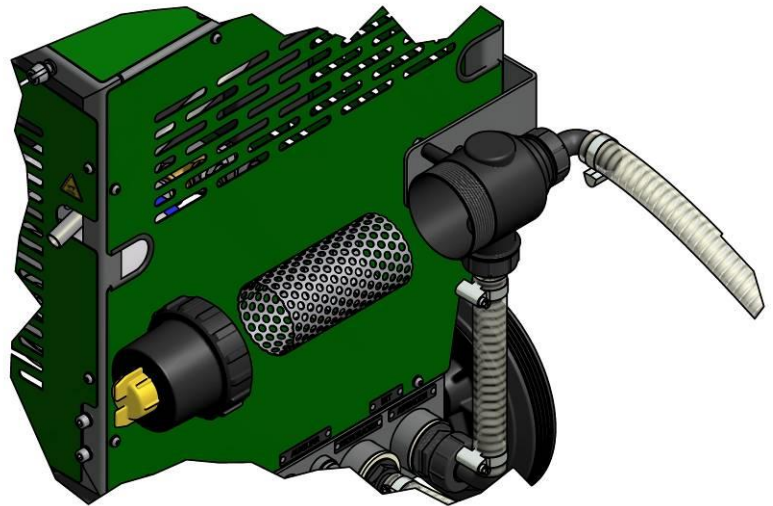

- n) Check the condition of the catalyst intake filter. Clean with clean water if necessary.
- o) Reconnect the hoses of the 2 intake and recirculation products to their respective containers, or new containers.

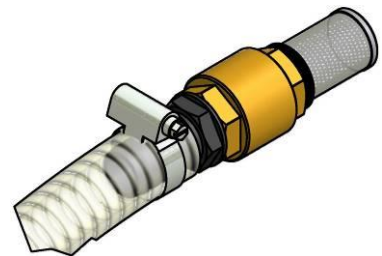

NOTE: Always clean the machine when it will not be used for more than 1 day.



STARTUP METHOD

Follow the recommended procedure, in the specified order, to start the machine when starting work:

- a) Check the oil level in the engine. Add oil if the level is low (read the engine service manual).
- b) Check the fuel level. Add gasoline if the level is low (read the engine service manual).
- c) Check the condition of the emulsion intake filter. Clean with diesel fuel if necessary.
- d) Check the condition of the catalyst intake filter. Clean with clean water if necessary.
- e) Make sure that all of the intake and recirculation hoses are securely connected and in their respective containers.
- f) Make sure that the valve on the emulsion filter is open.
- g) Make sure that the product output valves on the spray lance are closed.
- h) Make sure that the slots of the spray nozzles are oriented in the desired position. If not, turn to adjust them.
- i) Make sure that the slots of the spray nozzles are clean. Clean if necessary.
- j) Make sure that the valves on the control panel are in the spray position. If not, turn to adjust them.
- k) Insert the lance into the waste container to collect the cleaning agent accumulated in the hoses.
- l) Start the engine (see the specific sequence in the "STARTUP" section of the engine manual).

NOTE: To do this, follow the procedure described in the engine service manual.



Before starting the engine, make sure that all of the safety guards are in place and carefully read all of the technical and safety documentation included in the engine service manual and delivered along with each spray unit. It is very important that you pay attention to the information in the manual to understand the handling and conditions for using the engine. All of the information is aimed at improving the safety of the users and avoiding possible malfunctions due to incorrect use of the engine.

Never work with the engine running in an enclosed space; inhaling the exhaust gases could cause serious injury or even death.

- m) Set the revolutions per minute of the engine to approximately 3200.
- n) Open the manual valves on the lance and empty the contents of the hoses into the container.
- o) The cleaning process is considered to be finished when the products flow out clear of the contamination of the cleaning agents.
- p) Close the valves on the lance.

Dosing Unit BITUMEN-2K



Service Manual

- q) Turn the valves on the control panel to the recirculation position.
- w) Allow the two products to recirculate for approximately 10 minutes until they have mixed uniformly.

NOTE: *Before stopping the recirculation, make sure that there are no air bubbles in the hoses; if you see any bubbles, continue recirculating until they disappear.*

- x) Turn the valves on the control panel to the spray position.
- y) Adjust the emulsion pressure
- z) Adjust the catalyst pressure

WARNING! *Never exceed 10 Bar of pressure in the catalyst pump.*

- aa) Open the manual valves on the lance and test the spray in a small area. During the spray test, verify that the selected pressure values remain stable.
- bb) Close the manual valves on the lance when you are done spraying.



MALFUNCTIONS AND MAINTENANCE

See the engine service manual

Periodically check the belt tension. To tighten, loosen the anchor screws on the pump supports and turn the nuts on the tensioning bolts.

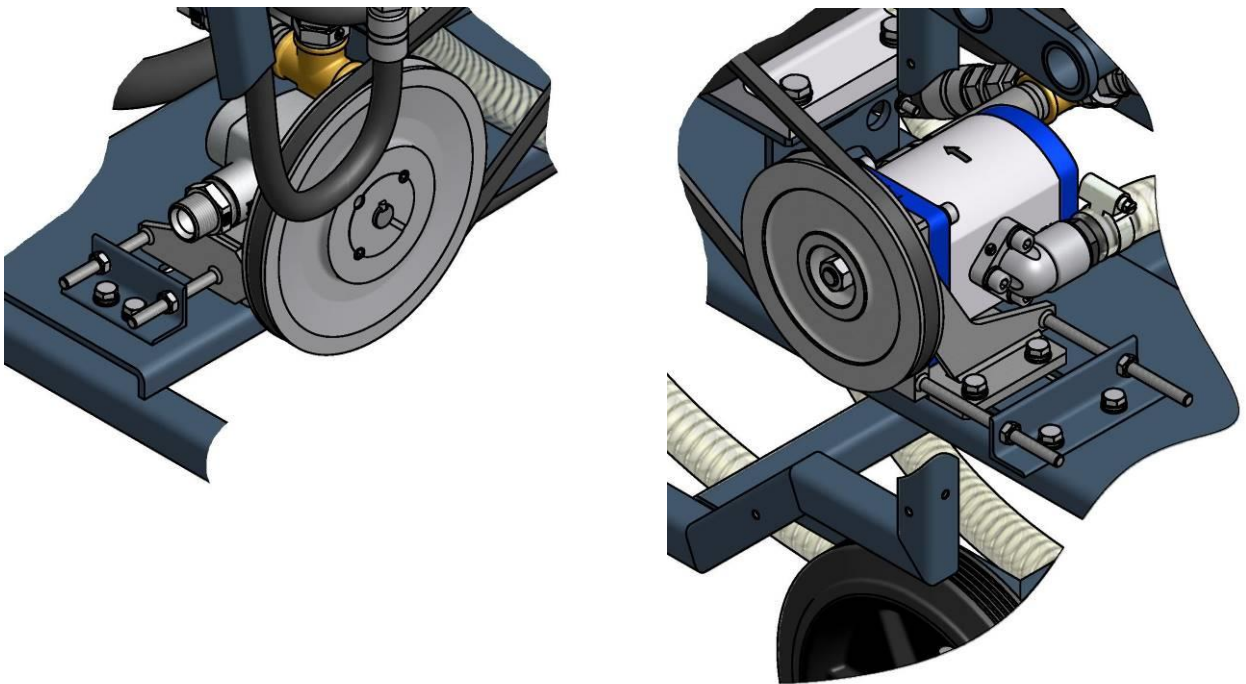

Replace the belts if they show signs of premature wear.



CONTENTS

Guarantee	2
Safety and Handling	3
Characteristics	6
Emulsion Delivery System	6
Catalyst Delivery System	6
Recirculation System	6
Gasoline Engine	6
Technical Specifications	7
General Description of Principal Components	8
Startup procedure	10
Shutdown Method	12
Cleaning Procedure	13
Startup Method	14
Malfunctions and maintenance	16
Contents	17
List of Illustrations	17

LIST OF ILLUSTRATIONS

Figure 1. General Description	8
--------------------------------------	----------